

www.rollytoys.de



rolly toys 1938 - 2023

85 Jahre
years
ans



2023

 made
 in
 Germany

Franz Schneider GmbH & Co. KG

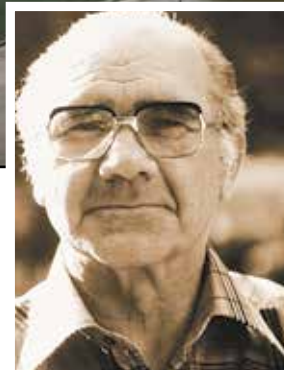

Das Spielwarenunternehmen wurde im Jahre 1938 von Franz und Rosa Schneider gegründet. Bis heute wird es in der zweiten und dritten Generation mit der Marke rolly toys als zukunftsorientiertes Familienunternehmen geführt. Seit 2020 ergänzt mit Ferbedo, eine weitere Traditionsmarke das Unternehmensportfolio der Franz Schneider GmbH & Co. KG.

The toy company was founded in 1938 by Franz and Rosa Schneider. To this day, the second and third generation company is run as a future-oriented family company with its brand rolly toys. Ferbedo, another traditional brand, has been supplementing the corporate portfolio of Franz Schneider GmbH & Co. KG since 2020.



...hat das Zeug
zum Spielen

L'entreprise de jouets a été fondée en 1938 par Franz et Rosa Schneider. Aujourd'hui encore, les deuxième et troisième générations de la famille continuent de diriger l'entreprise familiale, avec la marque roly toys, en tant qu'entreprise familiale tournée vers l'avenir. Depuis 2020, Ferbedo, une autre marque traditionnelle, complète le portefeuille d'entreprise de Franz Schneider GmbH & Co. KG.

L'azienda di giocattoli è stata fondata nel 1938 da Franz e Rosa Schneider. Ancora oggi viene gestita dalla seconda e terza generazione con il marchio roly toys come azienda familiare orientata al futuro. Dal 2020 il portfolio aziendale della Franz Schneider GmbH & Co. KG viene arricchito da Ferbedo, un altro marchio tradizionale.



Franz Schneider GmbH & Co. KG

Postfach 1460
D-96459 Neustadt bei Coburg
Germany
Tel.: 09568 / 856-0
Fax: 09568 / 856-190
E-Mail: info@rollytoys.de
www.rollytoys.de

Werk I - Verwaltung
Siemensstraße 13-19
D-96465 Neustadt bei Coburg
Germany

Werk II - Versand + Warenannahme
Franz-Schneider-Straße 1
D-96465 Neustadt bei Coburg
Germany

Rolly Toys Italiana S.R.L.
Via Colonna 9
I-31025 S.Lucia di Piave
Tel.: 0438 / 4466
Fax: 0438 / 27372

 **made
in
Germany**

Neuheiten
New
Nouveauté
Novita
2023



73 014 8 rollyFarmtrac Premium



134
122
104



Editorial	02 – 03
Neuheit, New, Nouveauté, Novita	04
Inhaltsverzeichnis	05
Erläuterungen, Explanations Explications, Informationi	06 – 09
rollyMinitrac	10 – 15
rollyKid / rolyKiddy	16 – 19
rollyKid licensed	20 – 27
rollyJunior RT	28 – 29
rollyJunior licensed	30 – 31
rollyFarmtrac	32 – 40
rollyFarmtrac Premium	41 – 52
rollyTruck	53 – 55
rollyX-Trac Premium licensed	56 – 58
rollyX-Trac Premium	59
rollyTrailer	60 – 73
rollyAccessoires	74 – 85
rollyDigger	86 – 88
rollyClassic Summer	89 – 91
rollySnow Champions	92 – 93
rollyOutdoor Games	94 – 95
rolly toys Quality	96 – 97
Index	98 – 99
Vertriebsagenturen Representatives Représentations Rappresentanti	100 – 101

Kindergrößen in Beziehung zu Fahrzeugtyp
Childrensize referring to the vehicle type
Le choix du tracteur se fera en fonction de la taille de l'enfant

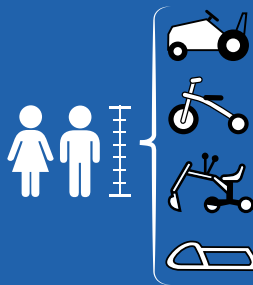

rollyMinitracs	= 68 – 104
Dreiradfahrzeuge	= 86 – 104
rollyKid	= 92 – 116
rollyJunior	= 104 – 134
rollyFarmtrac	= 104 – 134
rollyTruck-Line	= 104 – 134
rollyDigger	= 104 – 140
Snow Champions	= 104 – XXL
rollyX-Trac	= 110 – 140

(BG) Предупреждение!	(LT) Įspėjimas!	<p>A1</p>
(CZ) Varování!	(LV) Uzmanību!	
(D) Achtung!	(M) Avvis!	
(DK) Advarsel!	(MK) Внимание!	
(E) Aviso!	(N) OBS!	
(EST) Hoiatus!	(NL) Waarschuwing!	
(F) Attention!	(P) Aviso!	
(FIN) Varoitus!	(PL) Ostrożnie!	
(GB) Warning!	(RO) Avertisment!	
(GR) Προσοχή!	(RUS) Внимание!	
(H) Figyelmeztetés!	(S) Varning!	
(HR) Pažnja!	(SK) Varovanie!	
(I) Avviso!	(SLO) Opozorilo!	
(IRL) Rabhchán!	(TR) Dikkat!	

(BG) Предупреждение!	(LT) Įspėjimas!	<p>A2</p>
(CZ) Varování!	(LV) Uzmanību!	
(D) Achtung!	(M) Avvis!	
(DK) Advarsel!	(MK) Внимание!	
(E) Aviso!	(N) OBS!	
(EST) Hoiatus!	(NL) Waarschuwing!	
(F) Attention!	(P) Aviso!	
(FIN) Varoitus!	(PL) Ostrożnie!	
(GB) Warning!	(RO) Avertisment!	
(GR) Προσοχή!	(RUS) Внимание!	
(H) Figyelmeztetés!	(S) Varning!	
(HR) Pažnja!	(SK) Varovanie!	
(I) Avviso!	(SLO) Opozorilo!	
(IRL) Rabhchán!	(TR) Dikkat!	

- (BG) Внимание! Дребни части, които могат да бъдат погълнати. Опасност от задушаване!
- (CZ) Pozor! Spoknutelné drobné součásti. Nebezpečí udušení!
- (D) Achtung! Verschluckbare Kleinteile. Erstickungsgefahr!
- (DK) Forsigtig! Smådele kan sluges. Kvælningsrisiko!
- (E) Atención! Piezas pequeñas que pueden ser tragadas. Peligro de asfixia!
- (EST) Tähelepanu! Allaneelatavad pisidetailid. Lämbumisoht!
- (F) Attention! Petites pièces détachées. Danger d'étouffement à l'ingestion!
- (FIN) Huomio! Sisältää pieniä osia. Tukehdusvaara!
- (GB) Caution! Swallowable small parts. Danger of suffocation!
- (GR) Προσοχή! Πολύ μικρά κομμάτια (κατάποση). Κίνδυνος ασφυξίας!
- (H) Vigyázat! Lenyelhető kis darabok. Fulladásveszély!
- (HR) Pažnja! Sitni dijelovi koji se mogu progutati. Opasnost od gušenja!
- (I) Attenzione! Contiene piccole parti. Rischio di soffocamento!
- (IRL) Caution! Swallowable small parts. Danger of suffocation!
- (LT) Dėmesio! Sudėtyje yra smulkių detalių. Pavojus uždušiti!
- (LV) Uzmanību! Norījamas sīkas detaļas. Nosmakšanas briesmas!
- (M) Attenzioni! Partijet zghar li jistghu jinbelghu! Periklu ta' soffokazzjoni!
- (MK) Внимание! Мали делчиња кои што можат да се голтнат. Постои опасност од задушвање!
- (N) OBS! Svelgbare små deler. Kvælningsfare!
- (NL) Opgelet! Inslikbare kleine onderdelen. Verstikkingsgevaar!
- (P) Atenção! Peças pequenas possíveis de ser engolidas. Perigo de asfixia!
- (PL) Uwaga! Możliwość połknięcia drobnych elementów. Niebezpieczeństwo zadławienia!
- (RO) Atenție! Piese mici ce se pot înghiți. Pericol de asfixiere!
- (RUS) Внимание! Мелкие детали, которые случайно можно проглотить. Опасность задохнуться в результате попадания в дыхательные пути!
- (S) Se upp! Sväljbara smådelar. Risk för kvävning!
- (SK) Pozor! Prehltuteľné malé časti. Nebezpečenstvo udusenja!
- (SLO) Pozor! Vsebuje majhne dele. Nevarnost zadušitve!
- (TR) Dikkat! Yutabilir küçük parçalar. Boğulma tehlikesi!

- (BG) Внимание! Дълги връзки. Опасност от удушаване!
- (CZ) Pozor! Dlouhé šňůrky. Nebezpečí uškrcení!
- (D) Achtung! Lange Schnur. Strangulationsgefahr!
- (DK) Forsigtig! Lang snøre. Risiko for strangulering!
- (E) Atención! Cuerdas largas. Peligro de estrangulamiento!
- (EST) Tähelepanu! Pikad nõõrid. Poomisoht!
- (F) Attention! Longs cordons. Danger d'étranglement!
- (FIN) Huomio! Pitkät nauhat. Kuristumisen vaara!
- (GB) Caution! Long cord. Danger of strangulation!
- (GR) Προσοχή! Μακρά κορδόνια. Κίνδυνος πνιγμού!
- (H) Vigyázat! Hosszú zsinórok. Fojtásveszély!
- (HR) Pažnja! Dugi konopi. Opasnost od strangulacija!
- (I) Attenzione! Corde lunghe. Rischio di strangolamento!
- (IRL) Caution! Long cord. Danger of strangulation!
- (LT) Dėmesio! Ilgos virvės. Pavojus pasismaugti!
- (LV) Uzmanību! Garas auklas! Pakāšanās briesmas!
- (M) Attenzioni! Habel twil. Periklu ta' tghalliq!
- (MK) Внимание! Долги врвци. Постои опасност од давење!
- (N) OBS! Lange snorer. Strangulationsfare!
- (NL) Opgelet! Lange snoeren. Wurggevaar!
- (P) Atenção! Fios compridos. Perigo de estrangulamento!
- (PL) Uwaga! Długie sznury. Niebezpieczeństwo uduszenia!
- (RO) Atenție! Sfoară lungă. Pericol de strangulare!
- (RUS) Внимание! Длинные шнуры (веревки). Опасность удушения!
- (S) Se upp! Långa snören. Risk för strypning!
- (SK) Pozor! Dlhé šnúrky. Nebezpečenstvo uškrcenia!
- (SLO) Pozor! Dolge vrvice. Nevarnost zadušitve!
- (TR) Dikkat! Uzun ipler. Boğazın sıkılma tehlikesi!

Es gelten unsere allgemeinen Lieferbedingungen auf der Preisliste.
Technische Änderungen und Farbänderungen bleiben vorbehalten.

Our general delivery conditions written on the price list are valid.
All rights are reserved to make any technical modifications and colour changes.

Nous appliquons les conditions de livraison indiquées sur nos tarifs.
Sous réserve de modifications techniques et de changements de teintes.

Sono valide tutte le condizioni scritte riportate a listino.
Ci riserviamo tutti i diritti di apportare modifiche tecniche e cambiamenti di colore.

ERLÄUTERUNGEN

Die Bildunterschriften zu den Artikeln enthalten Angaben zur Artikelgröße (LxBxH), Artikelgewicht, Verpackungsgröße (LxBxH), Verpackungsgewicht, Verpackungsvolumen und Verpackungseinheit. Die von roly toys produzierten Artikel entsprechen der EU Norm EN 71. Alle Funktionsspielzeuge sind TÜV/GS geprüft und CE gekennzeichnet. Technische Änderungen, Farbänderungen und Änderungen im Design bleiben vorbehalten. Die roly toys Artikel werden teilmontiert ausgeliefert, die Endmontage darf nur von Erwachsenen durchgeführt werden.

EXPLANATIONS

The legend for each item includes details about the article size (LxWxH), article weight, packing size (LxWxH), packing weight, packing volume and packing unit. All items produced by roly toys are in accordance with the EU Norm EN 71. All function toys are examined by the German Technical inspection Authority (TÜV) and are safety tested (GS). Technical changes, colour changes and changes in design are subjects to modification. The roly toys items will be delivered partly assembled; the final assembly must only be carried out by an adult.

EXPLICATIONS

Chaque modèle est accompagné d' une légende qui indique: les dimensions du modèle (LxlxH), le poids du modèle, les dimensions du carton, les poids et le volume du carton, le colisage standard. Tous les modèles de la gamme roly toys répondent aux normes de sécurité EN 71 en vigueur dans la C.E.E. Tous les jouets de fonction sont contrôlés par le service des Mines allemand. Le fabricant se réserve le droit d' apporter sur ses modèles, si nécessaire, des modifications techniques, ainsi que des changements de couleur ou de dessin. Les articles roly toys sont livrés partiellement montés, le montage final doit impérativement être effectué par des adultes.

INFORMAZIONI

Descrizione dei simboli presenti sotto ogni articolo: misura dell' articolo, peso netto, misura dell' imballo, peso lordo, volume dell' imballo, pezzi per confezione. Tutti i nostri giocattoli vengono prodotti e collaudati in conformità degli standard di qualità internazionali EN 71 / ASTM. Tutti i giocattoli funzionali sono testate TÜV/GS. Ci riserviamo il diritto di apportare modifiche tecniche e cambiamenti nel design e nei colori. I prodotti Rolly toys vengono forniti parzialmente assemblati, il montaggio finale può essere eseguito solo da adulti.



rollyKonfigurator

rollyTrailer & Accessoires

- Serienausstattung
- ◐ Serienausstattung – Modell abhängig
- Zusatzausstattung
- ✳ Nur in Kombination mit rollyTrac Lader

rollyTracs

	rollyKid 01 ●●●● + 02 ●●●●	rollyDumperKid 01 ●●●●	rollyUnimog 03 ●●●●	rollyMinitrac 13 ●●●●	rollyFarmtrac 60 ●●●●	rollyFarmtrac 61 ●●●●	rollyKiddy 62 ●●●● + 63 ●●●●	rollyX-Trac Premium 64 ●●●● + 65 ●●●●	rollyFarmtrac Premium 70 ●●●●	rollyFarmtrac Premium 71 ●●●●	rollyFarmtrac Premium II 72 ●●●●	rollyFarmtrac Premium II 73 ●●●●	rollyJunior 80 ●●●●	rollyJunior 81 ●●●●	rollyTruck 88 ●●●●
rollyTrac Brake Farmtracs 40 944 0					○	○			○	○	○	◐	○	○	
rollyTrac Brake X-Trac Premium 40 992 1									◐						
rollyFlashlights 40 955 6 + 40 976 1	○	○	◐		○	○			○	○	○	○	○	○	○
rollyLight & Sound 40 959 4			○		○	○			○	○	○	○	○	○	○
rollySoundwheel 40 923 5	○	○	○	○	○	○	○	○	○	○	○	○	○	○	○
rollySnowgrip 40 969 3					○	○				○	○	○	○	○	
rollySnowgrip 40 966 2									○						
rollySnowgrip 40 965 5				○											○
rollyTrac Air Tyres 40 984 6					○	◐							○	○	
rollyTrac Air Tyres 40 924 2									○	◐	○	◐			
rollyTrac Air Tyres 40 918 1				○											○
rollyTrac Sweeper 40 ●●●●			◐		○	○			○	○	○	○	○	○	○
rollyBackhoe 40 ●●●●	○	○	○		○	○			○	○	○	○	○	◐	○
Lademontage + Adapter 2						○			○		○		○	*	
rollySnow Master 40 961 7				○					○	○	○	○	○	○	○
Frontkupplung + Adapter 1									○		○		○	*	
rollyTimber Loader 40 967 9						○									
rollyTrac Lader Premium 40 896 2									◐						
Abnehmbar!										○	●	○	●		
rollyTrac Lader 40 934 1					○	●				○	●	○	●	○	
Fixiert!														○	●
rollyJunior Lader 40 933 4														○	●
rollyKid Lader 40 931 0		◐					○								
rollyPowewinch 40 ●●●●				◐					○	○	○	○	○	○	○
rollyTrailer large 12 ●●●●					○	○			○	○	○	○	○	○	○
rollyTrailer small 12 ●●●●	○	○	○		○	○	○	○	○	○	○	○	○	○	○
rollyMinitrac Trailer 12 ●●●●				○											

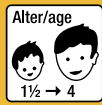

Altersangabe als Empfehlung
Recommended age
Indication d'âge purement indicative
Indicazione età consigliata



Maximale Belastbarkeit
Maximum loading capacity
Capacité maximale
Portata massima



Das Tragen von Schutzausrüstung wird dringend empfohlen
It is strongly recommended to wear protective gear
Il est fortement recommandé d'utiliser des équipements de protection
Si consiglia di indossare un equipaggiamento protettivo



Neueit
New item
Nouveauté
Novità



Garantie
Guarantee
Garantie
Garanzia



Batteriebetrieb
Battery-operated
Modèle avec batterie et chargeur fournis
Funziona a batteria



Sitzverstellung
Seat shift
Déplacement du siège
Sella regolabile



Lenkstange höhenverstellbar
Handlebar height-adjustable
Colonne de direction réglable en hauteur
Manubrio regolabile



Handbremse
Hand-brake
Frein à main
Freno a mano



Zweigangschaltung
Two gears
Deux vitesses
Cambio a doppia marcia



Lader
Loader
Pelleteuse
Caricatore



Lader abnehmbar
Loader to dismantle
Pelleteuse à démonter
Carrello di carico smontabile



Automatikverriegelung
Automatically bolted
Verrouillée automatiquement
Blocca automaticamente



Motorhaube zu öffnen
Bonnet opens
Capot ouvrant
Cofano apribile



Hupe
Horn
Klaxon
Clacson



Flüsterreifen
Noiseless tyres
Pneus silencieux
Ruote silenziose



Kettenschutz
Protected Chain
Chaîne protégée
Cingolo protetto



Luftbereifung
Pneumatic wheel
Pneu souples
Ruote gonfiabili



Die Spielwaren sind nur unter Aufsicht von Erwachsenen zu verwenden. Allgemeine Gefahren- und Gebrauchshinweise sind unbedingt zu beachten.

The toys are only to be used under adult supervision. General danger and usage notices must be unconditionally observed.

Les jouets doivent être utilisés sous la surveillance d'adultes. Les prescriptions de danger et les prescriptions d'utilisation doivent être impérativement respectées.

I giocattoli possono essere utilizzati solo sotto la supervisione di un adulto. Le istruzioni generali per l'uso e le avvertenze di pericolo devono essere rispettate rigorosamente.



1

STEYR
TRAKTOREN

CNI LICENSED
INDUSTRIAL PRODUCT



1 13 201 0 rollyMinitrac Steyr 4115 Multi

61x30x41 4,2 kg 1x

59x29,5x39 4,9 kg 0,068 m³



4 006485 132010

2 13 233 1 rollyMinitrac MF 5470

61x30x41 4,2 kg 1x

59x29,5x39 4,9 kg 0,068 m³



4 006485 132331



2



MASSEY FERGUSON

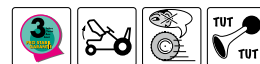

3 13 226 3 rollyMinitrac Case 165 CVX

61x30x41 4,2 kg 1x

59x29,5x39 4,9 kg 0,068 m³



4 006485 132263



3

CASE II
AGRICULTURE

CNI LICENSED
INDUSTRIAL PRODUCT

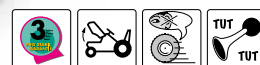

4 13 208 9 rollyMinitrac NH T6010

61x30x41 4,2 kg 1x

59x29,5x39 4,9 kg 0,068 m³



4 006485 132089



4

NEW HOLLAND
AGRICULTURE

CNI LICENSED
INDUSTRIAL PRODUCT



5 13 265 2 rollyMinitrac Claas Xerion

61x30x41 4,2 kg 1x

59x29,5x39 4,9 kg 0,068 m³



4 006485 132652

6 13 207 2 rollyMinitrac John Deere 6150 R

61x30x41 4,2 kg 1x

59x29,5x39 4,9 kg 0,068 m³



4 006485 132072

7 12 202 8 rollyMinitrac Trailer John Deere

34x30x25 1,8 kg 1x

32x32x25 2,2 kg 0,026 m³



4 006485 122028

CLAAS

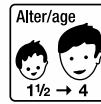

minitrac[®]

5



6

JOHN DEERE
LICENSED PRODUCT

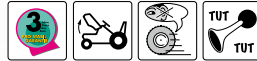

7



Ablage unter der Motorhaube
Storage space under the opening bonnet
Petit vide-poche sous le capot moteur
Cofano apribile con vano porta oggetti





1



www.cat.com / www.caterpillar.com
© 2023 Caterpillar. All Rights Reserved.
CAT, CATERPILLAR, their respective logos,
„Caterpillar Yellow,“ the „Power Edge“
trade dress as well as corporate and product
identity used herein, are trademarks of Caterpillar
and may not be used without permission.
rolly toys - Franz Schneider GmbH & Co. KG,
a licensee of Caterpillar Inc.



1 13 224 9 rollyMinitrac Dumper CAT

	63x30x41	4,6 kg	1x
	59x29,5x39	5,3 kg	0,068 m ³



4 006485 132249

2 13 564 6 rollyMinitrac Dumper JCB

	63x30x41	4,6 kg	1x
	59x29,5x39	5,3 kg	0,068 m ³



4 006485 135646

3 13 214 0 rollyMinitrac Dumper

	63x30x41	4,6 kg	1x
	59x29,5x39	5,3 kg	0,068 m ³



4 006485 132140

4 13 210 2 rollyMinitrac Deutz-Fahr 3060

	61x30x41	4,2 kg	1x
	59x29,5x39	4,9 kg	0,068 m ³



4 006485 132102

5 13 239 3 rollyMinitrac Valtra

	61x30x41	4,2 kg	1x
	59x29,5x39	4,9 kg	0,068 m ³



4 006485 132393

6 13 277 5 rollyMinitrac Lindner

	61x30x41	4,2 kg	1x
	59x29,5x39	4,9 kg	0,068 m ³



4 006485 132775

7 12 208 0 rollyMinitrac Trailer

	34x30x25	1,8 kg	1x
	32x32x25	2,2 kg	0,026 m ³



4 006485 122080



under permission of JCB



2

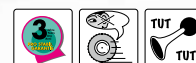

3



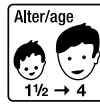

minitrac[®]

4



DEUTZ FAHR



VALTRA

5

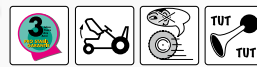

Lindner

6



7



rolly[®] carabella



1



1 13 242 3 rollyMinitrac Carabella

61x30x41 4,2 kg 1x

59x29,5x39 4,9 kg 0,068 m³



4 006485 132423

2 13 256 0 rollyMinitrac Volvo

97x30x41 6,0 kg 1x

64x29x45 6,6 kg 0,083 m³



4 006485 132560



3 16 101 0 rollyMinitruck Mack

61x30x41 4,2 kg 1x

59x29,5x39 4,9 kg 0,068 m³



4 006485 161010

2



4 16 100 3 rollyMinitruck Mack

61x30x41 4,2 kg 1x

59x29,5x39 4,9 kg 0,068 m³



4 006485 161003



MACK®

The MACK trademark and designs are registered rights of the AB Volvo Group and are used pursuant to a license.



3

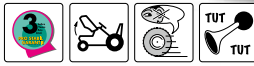

4

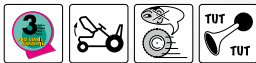

1



2



1 01 212 1 rollyKid-X

134x47x52 7,8 kg 1x
 81,5x40x45 9,2 kg 0,147 m³



4 006485 012121

2 02 312 7 rollyKid-X

161x47x55 9,2 kg 1x
 81,5x40x45 10,6 kg 0,147 m³



4 006485 023127

3 01 216 9 rollyKid-X

134x47x52 7,8 kg 1x
 81,5x40x45 9,2 kg 0,147 m³



4 006485 012169

4 02 313 4 rollyKid-X

161x47x55 9,2 kg 1x
 81,5x40x45 10,6 kg 0,147 m³



4 006485 023134

Alter/age
2½ → 5

Kid-X
rolly[®]

3



4





1



2



1 62 000 5 rollyKiddy Futura

134x47x49 7,0 kg 1x
 81,5x40x45 8,4 kg 0,147 m³



4 006485 620005

2 63 003 5 rollyKiddy Futura

162x47x53,5 8,6 kg 1x
 81,5x40x45 10,0 kg 0,147 m³



4 006485 630035

3 63 004 2 rollyKiddy Classic

162x47x53,5 8,6 kg 1x
 81,5x40x45 10,0 kg 0,147 m³



4 006485 630042

4 02 319 6 rollyKid Deutz-Fahr

161x47x55 9,4 kg 1x
 81,5x42,5x45 10,8 kg 0,156 m³



4 006485 023196

5 01 494 1 rollyKid Little Grey Fergie

133x46x50 7,6 kg 1x
 81,5x40x45 9,0 kg 0,147 m³



4 006485 014941

Alter/age
2½ → 5

rollyKis®

3



DEUTZ  **FAHR**

4



LITTLE GREY
FERGIE

5



1



CASE II
AGRICULTURE

CNI LICENSED PRODUCT
INDUSTRIAL



2



MASSEY FERGUSON



1 01 241 1 rolyKid Case 1170 CVX

134x47x52 8,0 kg 1x

81,5x40x45 9,4 kg 0,147 m³



4 006485 012411

2 01 230 5 rolyKid MF

134x47x52 7,8 kg 1x

81,5x40x45 9,2 kg 0,147 m³



4 006485 012305

3 01 215 2 rolyKid Zetor

82x44x52 6,1 kg 1x

81,5x40x45 7,5 kg 0,147 m³



4 006485 012152

Zetor

3



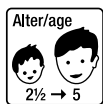

rollyKid

4



FENDT



CLAAS

5



4 01 316 6 rollyKid Fendt

134x47x52 8,0 kg 1x

81,5x42,5x45 9,4 kg 0,156 m³



4 006485 013166

5 02 507 7 rollyKid Claas Elios

110x47x55 8,2 kg 1x

81,5x40x45 9,6 kg 0,147 m³



4 006485 025077

STEYR

TRAKTOREN



1



2

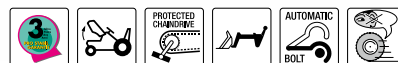

1 01 251 0 rollyKid Steyr 6165 CVT

134x47x52 8,2 kg 1x
 81,5x42,5x45 9,6 kg 0,156 m³



4 006485 012510

2 02 393 6 rollyKid Steyr 6165 CVT

161x47x55 9,6 kg 1x
 81,5x42,5x45 11,0 kg 0,156 m³



4 006485 023936

3 01 307 4 rollyKid NH T 7040

134x47x52 7,8 kg 1x
 81,5x40x45 9,2 kg 0,147 m³



4 006485 013074

4 02 392 9 rollyKid NH T 7040

161x47x55 9,2 kg 1x
 81,5x40x45 10,6 kg 0,147 m³



4 006485 023929

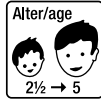

3



4



VALTRA

1



Landini

2



1 01 252 7 rolyKid Valtra

134x47x52 8,0 kg 1x
 81,5x40x45 9,4 kg 0,147 m³



3 01 219 0 rolyKid John Deere

134x47x52 7,8 kg 1x
 81,5x40x45 9,2 kg 0,147 m³



2 01 184 1 rolyKid Landini

134x47x52 8,0 kg 1x
 81,5x40x45 9,4 kg 0,147 m³



4 02 311 0 rolyKid John Deere

161x47x55 9,2 kg 1x
 81,5x40x45 10,6 kg 0,147 m³



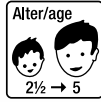

rollyKis

3

JOHN DEERE LICENSED PRODUCT



4



tüüüt tüüüt
brm brm brm



5



5 05 276 9 rollyTrac John Deere

109x47x56 4,9 kg 1x

64,5x39x37,5 6,0 kg 0,094 m³



4 006485 052769



JCB

under permission of JCB



1



2

1 01 261 9 rollyKid JCB

134x47x52 8,0 kg 1x

81,5x40x45 9,4 kg 0,147 m³



4 006485 012619



2 02 383 7 rollyKid JCB

161x47x55 9,4 kg 1x

81,5x42,5x45 10,8 kg 0,156 m³



4 006485 023837



3 02 424 7 rollyKid Dumper JCB

93x44x52 6,6 kg 1x

81,5x40x45 8,0 kg 0,147 m³



4 006485 024247

3

4 02 328 8 rollyKid CAT

161x47x55 9,2 kg 1x

81,5x40x45 10,6 kg 0,147 m³



4 006485 023288

5 02 417 9 rollyKid Dumper CAT

93x44x52 6,6 kg 1x

81,5x40x45 8,0 kg 0,147 m³



4 006485 024179



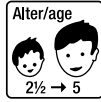

rollyKis

4



www.cat.com / www.caterpillar.com
© 2023 Caterpillar. All Rights Reserved.
CAT, CATERPILLAR, their respective logos,
„Caterpillar Yellow,“ the „Power Edge“
trade dress as well as corporate and product
identity used herein, are trademarks of Caterpillar
and may not be used without permission.
rolly toys - Franz Schneider GmbH & Co. KG,
a licensee of Caterpillar Inc.

5



6

tüüüt tüüüt
brm brm brm



6 05 293 6 rollyTrac CAT

	109x47x56		4,9 kg		1x
	64,5x39x37,5		6,0 kg		0,094 m³



4 006485 052936



1



2



1 80 026 1 rollyJunior RT

162x53x62 12,0 kg 1x

117,8x40,4x56,4 14,0 kg 0,268 m³



4 006485 800261

2 81 146 5 rollyJunior RT

142x53x62 11,2 kg 1x

102,8x40,4x56,4 13,0 kg 0,234 m³



4 006485 811465

3 81 139 7 rollyJunior RT

210x53x62 13,6 kg 1x

117,8x40,4x56,4 15,6 kg 0,268 m³



4 006485 811397

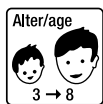

rolly®
junior

3



rollyPowerwinch s. 78





1



www.cat.com / www.caterpillar.com
 © 2023 Caterpillar. All Rights Reserved.
 CAT, CATERPILLAR, their respective logos,
 „Caterpillar Yellow,“ the „Power Edge“
 trade dress as well as corporate and product
 identity used herein, are trademarks of Caterpillar
 and may not be used without permission.
 rolly toys - Franz Schneider GmbH & Co. KG,
 a licensee of Caterpillar Inc.



JOHN DEERE

LICENSED PRODUCT



2



1 81 300 1 rollyJunior CAT

164,5x53x76 13,0 kg 1x
 117,8x40,4x56,4 15,0 kg 0,268 m³



4 006485 813001

2 81 107 6 rollyJunior John Deere

164,5x53x76 13,0 kg 1x
 117,8x40,4x56,4 15,0 kg 0,268 m³



4 006485 811076

3 81 200 4 rollyJunior JCB

164,5x53x76 13,0 kg 1x
 117,8x40,4x56,4 15,0 kg 0,268 m³



4 006485 812004

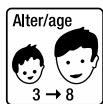

**rolly®
junior**

3



JCB

under permission of JCB



Heckbagger mit Verriegelung
Excavator with locking mechanism
Pelle avec verrouillage
Escavatore posteriore con fermo





MASSEY FERGUSON

1



2



3



1 60 115 8 rollyFarmtrac MF

106x53x60 9,3 kg 1x

102,8x40,4x56,4 11,1 kg 0,234 m³



4 006485 601158

2 61 113 3 rollyFarmtrac MF

142x53x81 12,6 kg 1x

110x52x54 15,0 kg 0,309 m³



4 006485 611133

3 61 114 0 rollyFarmtrac MF

142x53x81 16,4 kg 1x

110x52x54 18,8 kg 0,309 m³



4 006485 611140

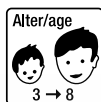

rolly
FARMTRAC

4

FENDT



5



4 60 102 8 rollyFarmtrac Fendt 211 Vario

106x53x60 9,3 kg 1x

117,8x40,4x56,4 11,3 kg 0,268 m³



4 006485 601028

5 61 105 8 rollyFarmtrac Fendt 211 Vario

142x53x81 12,6 kg 1x

110x52x54 15,0 kg 0,309 m³



4 006485 611058

6 61 108 9 rollyFarmtrac Fendt 211 Vario

142x53x81 16,4 kg 1x

110x52x54 18,8 kg 0,309 m³



4 006485 611089

6



1



2



1 60 124 0 rollyFarmtrac Deutz-Fahr

	106x53x60		9,3 kg		1x
	102,8x40,4x56,4		11,1 kg		0,234 m ³



2 61 120 1 rollyFarmtrac Deutz-Fahr

	142x53x81		12,6 kg		1x
	110x52x54		15,0 kg		0,309 m ³



3 61 121 8 rollyFarmtrac Deutz-Fahr

	142x53x81		16,4 kg		1x
	110x52x54		18,8 kg		0,309 m ³



4 61 100 3 rollyFarmtrac JCB 8250

	142x53x81		12,6 kg		1x
	110x52x54		15,0 kg		0,309 m ³



3



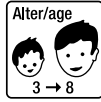

Frolly[®]
FARMTRAC

JCB

under permission of JCB



4



CASE II

AGRICULTURE



1



2



3



1 60 105 9 rollyFarmtrac Case Puma

106x53x60 9,3 kg 1x

102,8x40,4x56,4 11,1 kg 0,234 m³



4 006485 601059

2 61 106 5 rollyFarmtrac Case Puma

142x53x81 12,6 kg 1x

110x52x54 15,0 kg 0,309 m³



4 006485 611065

3 61 112 6 rollyFarmtrac Case Puma

142x53x81 16,4 kg 1x

110x52x54 18,8 kg 0,309 m³



4 006485 611126

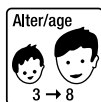

rolly
FARMTRAC



4



5



6



4 60 129 5 rolyFarmtrac NH

106x53x60 9,3 kg 1x

102,8x40,4x56,4 11,1 kg 0,234 m³



4 006485 601295

5 61 125 6 rolyFarmtrac NH

142x53x81 12,6 kg 1x

110x52x54 15,0 kg 0,309 m³



4 006485 611256

6 61 127 0 rolyFarmtrac NH

142x53x81 16,4 kg 1x

110x52x54 18,8 kg 0,309 m³



4 006485 611270



Mercedes-Benz

and Mercedes-Benz are the intellectual property of Mercedes-Benz Group AG. They are used by Franz Schneider GmbH & Co. KG under license. All truck-specific claims, trademarks, logos and designs may be intellectual property of Daimler Truck AG and are used by Franz Schneider GmbH & Co. KG under license.

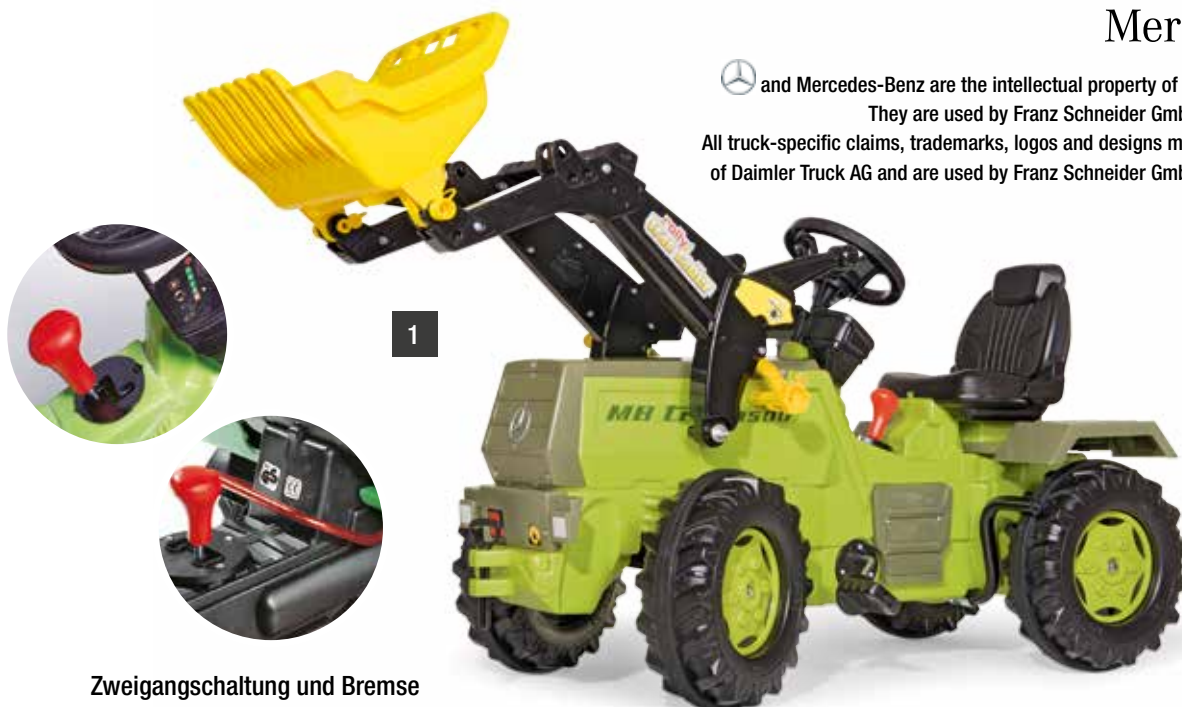

Zweigangschaltung und Bremse
 Two gears and brake
 Deux vitesses et frein
 Cambio a doppia marcia e freno



1 04 669 0 rollyFarmtrac MB 1500

148x51x66 12,8 kg 1x
 113,5x52x52 15,0 kg 0,307 m³



2 60 106 6 rollyFarmtrac JD 6210 R

106x53x60 9,3 kg 1x
 117,8x40,4x56,4 11,3 kg 0,268 m³



3 61 109 6 rollyFarmtrac JD 6210 R

142x53x81 12,6 kg 1x
 110x52x54 15,0 kg 0,309 m³



4 61 110 2 rollyFarmtrac JD 6210 R

142x53x81 16,4 kg 1x
 110x52x54 18,8 kg 0,309 m³



JOHN DEERE

LICENSED PRODUCT



Alter/age
3 → 8

Frolly[®]
FARMTRAC



3



4



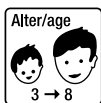

CLAAS



1



2



Mit beidseitiger Verriegelung
With locking on both sides
Avec double verrouillage
Con doppia chiusura



1 60 104 2 rollyFarmtrac Claas Axos 340

106x53x60 9,3 kg 1x
 102,8x40,4x56,4 11,1 kg 0,234 m³



4 006485 601042

2 61 104 1 rollyFarmtrac Claas Axos 340

142x53x81 12,6 kg 1x
 110x52x54 15,0 kg 0,309 m³



4 006485 611041

3 72 006 4 rollyFarmtrac Claas Arion 640

114x52,5x65,5 12,2 kg 1x
 119,5x55x54 14,3 kg 0,355 m³



4 006485 720064

4 73 010 0 rollyFarmtrac Claas Arion 640

150x52,5x76 14,2 kg 1x
 119,5x55x54 17,1 kg 0,355 m³



4 006485 730100

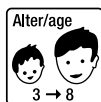

Froly® FARMTRAC

Premium

3



CLAAS



4

Der Schaufellader ist komplett abnehmbar
The shovel loader can be removed completely
Le chargeur à pelle est entièrement démontable
Le rollyTrac Lader può essere completamente smontata



STEYR

TRAKTOREN

CNI INDUSTRIAL LICENSED PRODUCT



1



2



1 72 000 2 rollyFarmtrac Steyr 6300 Terrus CVT

114x52,5x65 12,2 kg 1x

119,5x55x54 14,1 kg 0,355 m³



4 006485 720002

2 73 000 1 rollyFarmtrac Steyr 6300 Terrus CVT

150x52,5x76 14,2 kg 1x

119,5x55x54 17,1 kg 0,355 m³



4 006485 730001

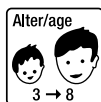

rolly[®] FARMTRAC

Premium



3



3 73 002 5 rollyFarmtrac Steyr 6300 Terrus CVT

	150x52,5x76		17,6 kg		1x
	119,5x55x54		21,8 kg		0,355 m ³



4 006485 730025

1



2



1 72 005 7 rollyFarmtrac Deutz-Fahr

114x52,5x65 12,2 kg 1x

119,5x55x54 14,1 kg 0,355 m³



4 006485 720057

2 73 008 7 rollyFarmtrac Deutz-Fahr

150x52,5x76 14,2 kg 1x

119,5x55x54 17,1 kg 0,355 m³



4 006485 730087

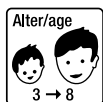

rolly[®]
FARMTRAC

Premium



3



3 73 009 4 rollyFarmtrac Deutz-Fahr

	150x52,5x76		17,6 kg		1x
	119,5x55x54		21,8 kg		0,355 m ³



4 006485 730094



Die patentierte rolly toys Sitzverstellung
jetzt auch bei der rollyFarmtrac Premium-Linie

The patented rolly toys seat adjustment
now also on the rollyFarmtrac Premium line



Der Schaufellader ist komplett abnehmbar
The shovel loader can be removed completely
Le chargeur à pelle est entièrement démontable
Le rollyTrac Lader può essere completamente smontata

Mit beidseitiger Verriegelung
With locking on both sides
Avec double verrouillage
Con doppia chiusura



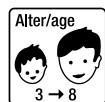

rolly[®] FARMTRAC

Premium



1



1 73 014 8 rollyFarmtrac Deutz-Fahr Warrior

	150x54x75		14,2 kg		1x
	120x54x55		16,6 kg		0,355 m ³



JOHN DEERE

LICENSED PRODUCT

Mit beidseitiger Verriegelung
With locking on both sides
Avec double verrouillage
Con doppia chiusura



1



Der Schaufellader ist komplett abnehmbar
The shovel loader can be removed completely
Le chargeur à pelle est entièrement démontable
La rollyTrac Lader può essere completamente smontata

2



1 70 002 8 rollyFarmtrac John Deere 7930

114x52,5x65,5 12,2 kg 1x

110x52x54 14,6 kg 0,309 m³



4 006485 700028

2 71 002 7 rollyFarmtrac John Deere 7930

146x52,5x77 14,7 kg 1x

110x52x54 17,1 kg 0,309 m³



4 006485 710027

3 71 012 6 rollyFarmtrac John Deere 7930

146x52,5x77 20,4 kg 1x

110x52x54 22,8 kg 0,309 m³



4 006485 710126

4 73 003 2 rollyFarmtrac John Deere 7310R

150x52,5x76 14,2 kg 1x

119,5x55x54 17,1 kg 0,355 m³



4 006485 730032



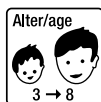

Frolly[®] FARMTRAC

Premium

3



4



Zweigangschaltung und Bremse
Two gears and brake
Deux vitesses et frein
Cambio a doppia marcia e freno



FENDT



1



2



1 71 026 3 rollyFarmtrac Fendt

146x52,5x78 14,7 kg 1x
 110x52x55 17,1 kg 0,309 m³



3 73 005 6 rollyFarmtrac Valtra

150x52,5x76 14,2 kg 1x
 119,5x55x54 17,1 kg 0,355 m³



2 71 029 4 rollyFarmtrac Fendt

146x52,5x77 20,4 kg 1x
 110x52x54 22,8 kg 0,309 m³



4 72 003 3 rollyFarmtrac Valtra

114x52,5x65 12,2 kg 1x
 119,5x55x54 14,6 kg 0,355 m³



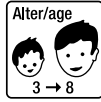

Frolly[®]
FARMTRAC

Premium



VALTRA

3



4



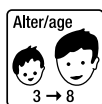

**rolly®
FARMTRAC**

Premium

Lindner

1



2



1 72 007 1 rollyFarmtrac Lintrac

114x52,5x65 12,2 kg 1x

119,5x55x54 14,6 kg 0,355 m³



4 006485 720071

2 73 011 7 rollyFarmtrac Lintrac

150x52,5x76 14,2 kg 1x

119,5x55x54 17,1 kg 0,355 m³



4 006485 730117



rolly®
Truck-Line

VOLVO

The VOLVO trademarks (word and device), other related trademarks, if applicable, and the Volvo designs are licensed by the AB Volvo Group



3

3 88 100 0 rollyTruck Volvo

 126x51x59,5  13,2 kg  1x

 120x56x57,5  16,0 kg  0,386 m³





Mercedes-Benz

and Mercedes-Benz are the intellectual property of Mercedes-Benz Group AG. They are used by Franz Schneider GmbH & Co. KG under license. All truck-specific claims, trademarks, logos and designs may be intellectual property of Daimler Truck AG and are used by Franz Schneider GmbH & Co. KG under license.



1



1 03 822 0 rollyUnimog Fire

	118x54x81		17,2 kg		1x
	119,5x54x55		19,8 kg		0,355 m ³



2

2 03 823 7 rollyUnimog Service

	118x54x81		17,2 kg		1x
	119,5x54x55		19,8 kg		0,355 m ³



3 03 824 4 rollyUnimog Forst

	130x54x73		15,8 kg		1x
	119,5x54x55		18,4 kg		0,355 m ³



4 03 825 1 rollyUnimog Polizei

	118x54x81		17,2 kg		1x
	119,5x54x55		19,8 kg		0,355 m ³



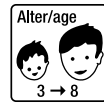

rolly
Truck-Line



Mercedes-Benz

3



4



JOHN DEERE

LICENSED PRODUCT

1



2



1 64 003 4 rollyX-Trac Premium John Deere

119x71x56,5 15,1 kg 1x
 120x57,5x57 18,0 kg 0,393 m³



2 65 104 7 rollyX-Trac Premium John Deere

154x91x56,5 17,9 kg 1x
 120x57,5x57 20,7 kg 0,393 m³



3 65 107 8 rollyX-Trac Premium John Deere

154x91x56,5 19,2 kg 1x
 120x57,5x57 22 kg 0,393 m³



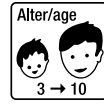

reilly®
X-trac
Premium

3

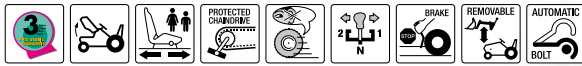

CLAAS

1



2

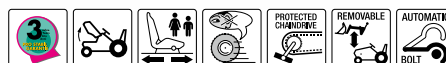

3

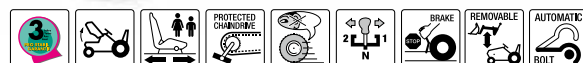

1 64 008 9 rollyX-Trac Premium Claas

	119x71x56,5		15,1 kg		1x
	120x57,5x57		18,0 kg		0,393 m ³



2 65 109 2 rollyX-Trac Premium Claas

	154x91x56,5		17,9 kg		1x
	120x57,5x57		20,7kg		0,393 m ³



3 65 112 2 rollyX-Trac Premium Claas

	154x91x56,5		19,2 kg		1x
	120x57,5x57		22,0 kg		0,393 m ³



4

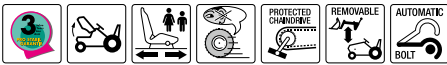

5

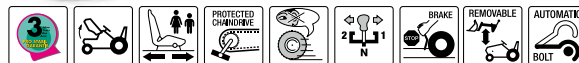

Zweigangschaltung und Bremse
Two gears and brake
Deux vitesses et frein
Cambio a doppia marcia e freno



4 65 100 9 rollyX-Trac Premium

154x91x56,5 17,9 kg 1x
120x57,5x57 20,7kg 0,393 m³



5 65 101 6 rollyX-Trac Premium

154x91x56,5 19,2 kg 1x
120x57,5x57 22,0 kg 0,393 m³



1



Mit Kurbel
With Crank
Avec manivelle
Con manovella



JOHN DEERE
LICENSED PRODUCT

2



1 12 501 2 rollyMulti Trailer

113x45,5x63 14,6 kg 1x
 94,5x42x47 16,2 kg 0,187 m³



2 12 504 3 rollyMulti Trailer John Deere

113x45,5x63 14,6 kg 1x
 94,5x42x47 16,2 kg 0,187 m³



3 12 500 5 rollyMulti Trailer

113x45,5x48 10,0 kg 1x
 87x40x47 11,4 kg 0,164 m³





rollyTrailer



3

Anhängerkupplung hinten
Trailer hitch behind
Crochet d'attelage arrière
Rimorchio intoppo dietro



1



ausgezeichnet 1996



1 12 110 6 rollyMega Trailer

88x45x47 7,9 kg 1x

88x24,2x43,5 9,1 kg 0,093 m³



4 006485 121106

2 12 150 2 rollyMega Trailer

88x45x47 7,9 kg 1x

88x24,2x43,5 9,1 kg 0,093 m³



4 006485 121502

3 12 220 2 rollyMega Trailer

88x45x47 7,9 kg 1x

88x24,2x43,5 9,1 kg 0,093 m³



4 006485 122202

4 12 200 4 rollyMega Trailer

88x45x47 7,9 kg 1x

88x24,2x43,5 9,1 kg 0,093 m³



4 006485 122004

5 12 301 8 rollyMega Trailer

88x45x47 7,9 kg 1x

88x24,2x43,5 9,1 kg 0,093 m³



4 006485 123018

2



3



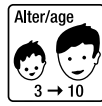

rollyTrailer

4



5



Mit Kurbel
With crank
Avec manivelle
Con manovella





1

JOHN DEERE
LICENSED PRODUCT



1 12 216 5 rollyHalpipe JD

	89x45x43		5,8 kg		1x
	79x31x42		6,8 kg		0,103 m ³



4 006485 122165



2 12 224 0 rollyHalpipe Deutz-Fahr

	89x45x43		5,8 kg		1x
	79x31x42		6,8 kg		0,103 m ³



4 006485 122240



2



3 12 319 3 rollyHalpipe Single

	76x45x42,5		3,6 kg		1x
	79x31x42		4,6 kg		0,103 m ³



4 006485 123193

4 12 221 9 rollyHalpipe Claas

	89x45x43		5,8 kg		1x
	79x31x42		6,8 kg		0,103 m ³



4 006485 122219

5 12 326 1 rollyHalpipe Krampe HP20

	89x45x43		5,8 kg		1x
	79x31x42		6,8 kg		0,103 m ³



4 006485 123261



3



6 12 323 0 rollyHalpipe Krampe

	89x45x43		5,8 kg		1x
	79x31x42		6,8 kg		0,103 m ³



4 006485 123230



rollyTrailer

CLAAS



4



5

Krampe
QUALITÄT AUF RÄDERN



6





1 12 393 3 rollyContainer Set

- 98x45x51 10,7 kg 1x
- 101x59x49 13,1 kg 0,292 m³



2 12 509 8 rollyContainer John Deere

- 98x45x51 8,4 kg 1x
- 94,5x42x47 10,0 kg 0,187 m³



3 12 322 3 rollyContainer Krampe

- 98x45x51 8,4 kg 1x
- 94,5x42x47 10,0 kg 0,187 m³



4 12 320 9 rollyMulti Trailer Joskin

- 113x45,5x48 11,8 kg 1x
- 94,5x42x47 13,4 kg 0,187 m³



5 12 226 4 rollyHalbpipe Joskin

- 89x45x43 5,8 kg 1x
- 79x31x42 6,8 kg 0,103 m³



JOHN DEERE
LICENSED PRODUCT





rollyTrailer

3



Krampe

QUALITÄT AUF RÄDERN



JOSKIN

4



Mit Kurbel
With Crank
Avec manivelle
Con manovella



5





Wasserhahn mit großer Wasserglocke
 Tap with water spreader device
 Robinet – grand debit
 Rubinetto con getto a ventaglio

1 12 212 7 rollyTanker

	98x44x55		5,6 kg		1x
	72x47x40		7,0 kg		0,135 m³



2 12 277 6 rollyTanker

	98x46x62		4,7 kg		1x
	72x47x40		6,1 kg		0,135 m³



3 12 265 3 rollyTanker

	98x44x55		5,6 kg		1x
	72x47x40		7,0 kg		0,135 m³



4 12 275 2 rollyTanker John Deere

	98x44x62		6,0 kg		1x
	72x47x40		7,4 kg		0,135 m³



5 12 296 7 rollyVacumax Fire

	75x45x43		2,7 kg		1x
	73x31x28		3,5 kg		0,063 m³



6 12 286 8 rollyVacumax

	75x45x43		2,7 kg		1x
	73x31x28		3,5 kg		0,063 m³



7 40 940 2 rollyPompa

	30x10x10		0,3 kg		1x
	30,5x10,5x10,5		0,4 kg		0,003 m³





rollyTrailer

JOHN DEERE
LICENSED PRODUCT



7
Pumpe mit Spritze
Pump with spray nozzle
Pompe avec arroseur
Pompa con spruzzatore

Passt an alle roly toys Tankwagen
Fits all roly toys tankers
Étudié pour toutes les citernes tractées
Va bene per tutti i serbatoi



1 12 885 3 rollyKipper II Claas

56x46,5x34 2,4 kg 1x
 52,5x28,5x40 3,1 kg 0,060 m³



2 12 884 6 rollyKipper II

56x46,5x34 2,4 kg 1x
 52,5x28,5x40 3,1 kg 0,060 m³



3 12 881 5 rollyKipper II

56x46,5x34 2,4 kg 1x
 52,5x28,5x40 3,1 kg 0,060 m³



4 12 882 2 rollyKipper II John Deere

56x46,5x34 2,4 kg 1x
 52,5x28,5x40 3,1 kg 0,060 m³



5 12 215 8 rollyTimber Trailer

82x46x65 6,0 kg 1x
 89x34x43 7,4 kg 0,130 m³



6 40 963 1 rollyTimber

58x9,5x9,5 1,3 kg 1x
 64x32x23 1,7 kg 0,047 m³



7 12 247 9 rollyHay Wagon Pöttinger

83x40x67 5,6 kg 1x
 79x43x25 6,6 kg 0,085 m³



8 12 298 1 rollyHay Wagon

83x40x67 5,6 kg 1x
 79x43x25 6,6 kg 0,085 m³



CLAAS



1



2



3



4



JOHN DEERE
 LICENSED PRODUCT



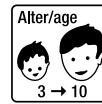

rollyTrailer

5



Automatikverriegelung
Automatic locking
Verrouillage automatique
Fermo automatico



6x Rundhölzer aus Kunststoff
6x plastic woodround
6x rouleau de bois en plastique
6x tronchi in plastica



6



7



8



JOHN DEERE

LICENSED PRODUCT



1 12 209 7 rollyFarm Trailer

62x46x37 3,1 kg 1x
 64x23x32 3,5 kg 0,047 m³



4 006485 122097

2 12 210 3 rollyFarm Trailer John Deere

62x46x37 3,1 kg 1x
 64x23x32 3,5 kg 0,047 m³



4 006485 122103

3 12 174 8 rollyKid Trailer

57x46,5x26,5 4x1,55 kg 4x
 87x34,5x54 7,5 kg 0,162 m³



4 006485 121748

4 12 172 4 rollyKid Trailer

57x46,5x26,5 4x1,55 kg 4x
 87x34,5x54 7,5 kg 0,162 m³



4 006485 121724

5 12 176 2 rollyKid Trailer

57x46,5x26,5 4x1,55 kg 4x
 87x34,5x54 7,5 kg 0,162 m³



4 006485 121762

6 12 171 7 rollyKid Trailer

57x46,5x26,5 4x1,55 kg 4x
 87x34,5x54 7,5 kg 0,162 m³



4 006485 121717



rollyKid Trailer





rollyTrailer

JOHN DEERE

LICENSED PRODUCT



7



Geschützter Integralantrieb
Covered integral drive
transmission protégée
Trasmissione con protezione

AMAZONE



8



7 12 511 1 rollyStreumax John Deere

	69x47,5x49		4,4 Kg		1x
	59x37,5x44		5,4 Kg		0,097 m³



4 006485 125111







8 12 510 4 rollyStreumax Amazone

	69x47,5x49		4,4 Kg		1x
	59x37,5x44		5,4 Kg		0,097 m³









4 006485 125104

1 12 386 5 rollyScraper

 69x35x35  1,8 kg  1x
 63x23x12  2,0 kg  0,017 m³









2 12 381 0 rollyFarm Roller

 56x52x25  3,0 kg  1x
 56,5x26,5x26,5  3,6 kg  0,040 m³



3 12 384 1 rollyCambridge

 61x90x27  5,4 kg  1x
 52,5x35x24  6,0 kg  0,044 m³



4 40 892 4 rollyBox Claas

 44x31x21  1,9 kg  1x
 45x30,5x23  2,3 kg  0,032 m³



5 40 894 8 rollyBox

 44x31x21  1,9 kg  1x
 45x30,5x23  2,3 kg  0,032 m³



6 40 893 1 rollyBox

 44x31x21  1,9 kg  1x
 45x30,5x23  2,3 kg  0,032 m³



7 40 889 4 rollyBox rollyMilchkannen

 44x31x21  2,4 kg  1x
 45x30,5x23  3,0 kg  0,032 m³



8 40 938 9 rollyMilk Churns (4 pcs)

 21x10,5x10,5  4,4 kg  6x
 73x51x28  5,0 kg  0,104 m³



1



2



3



rolly BOX

4



6



5



7



8



- rollyKiddy
- rollyKid



40 931 0 rollyKid Lader

	61x37x31		1,9 kg		1x
	41x21x32		2,2 kg		0,028 m ³



- rollyJunior



40 933 4 rollyJunior Lader

	81x37x33		2,1 kg		1x
	64x23x32		2,5 kg		0,047 m ³

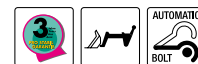

- rollyFarmtrac
- rollyFarmtrac Classic
- rollyFarmtrac Premium
- rollyX-Trac
- rollyX-Trac Premium



40 934 1 rollyTrac Lader

	83x35x40		2,7 kg		1x
	58,5x43,5x38,5		3,5 kg		0,098 m ³

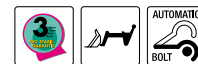

- rollyFarmtrac
- rollyFarmtrac Classic
- rollyFarmtrac Premium
- rollyX-Trac
- rollyX-Trac Premium



40 939 6 rollyTrac Lader

	83x35x40		2,7 kg		1x
	58,5x43,5x38,5		3,5 kg		0,098 m ³





40 895 5 rollyTrac Lader Premium

85x50,5x36 2,8 kg 1x

59,5x43,5x38,5 3,6 kg 0,100 m³



rollyX-Trac Premium



40 896 2 rollyTrac Lader Premium

85x50,5x36 2,8 kg 1x

59,5x43,5x38,5 3,6 kg 0,100 m³



rollyX-Trac Premium



40 967 9 rollyTimber Loader

42x35x30 1,0 kg 1x

37x30x17 1,2 kg 0,019 m³



- rollyFarmtrac
- rollyFarmtrac Classic
- rollyFarmtrac Premium
- rollyX-Trac
- rollyX-Trac Premium



Für Traktoren mit rollyTrac Lader
 For tractors with rollyTrac Lader
 Pour tracteurs avec chargeur rollyTrac Lader
 Adattabile a trattori con ruspa rollyTrac Lader



1



2



3



4



1 40 900 6 rollyPowerwinch

	38x8x26		0,8 kg		1x
	40x27x12		1,0 kg		0,013 m ³



4 006485 409006

2 40 928 0 rollyPowerwinch

	38x8x26		0,8 kg		1x
	40x27x12		1,0 kg		0,013 m ³



4 006485 409280

3 40 898 6 rollyPowerwinch

	38x8x26		0,8 kg		1x
	40x27x12		1,0 kg		0,013 m ³



4 006485 408986

4 40 972 3 rollySweepy

	49x44x40		3,1 kg		1x
	52x36x26,5		3,7 kg		0,050 m ³



4 006485 409723

5 40 970 9 rollyTrac Sweeper

	65x57,5x44		4,3 kg		1x
	60x58,5x23		5,2 kg		0,081 m ³



4 006485 409709

6 40 961 7 rollySnow Master

	55x34,5x13,5		2,8 kg		1x
	56,5x34x19,5		3,2 kg		0,037 m ³



4 006485 409617

7 40 899 3 rollySnow Master

	55x34,5x13,5		2,8 kg		1x
	56,5x34x19,5		3,2 kg		0,037 m ³



4 006485 408993

Frontanbau – Heckanbau
 Front-attachment – rear-attachment
 Montage frontale – montage arrière
 Montaggio frontale – montaggio posteriore

Voll funktionstüchtige Anbaukehrmaschine, mit rotierender Bürstenwalze. Der Auffangbehälter ist zum Entleeren abnehmbar.

Fully functional road sweeper, with rotating brush roller. The collection container can be removed to be emptied.

Balayeuse fonctionnelle, avec rouleau brosser rotatif. Le réservoir collecteur est démontable pour l'évacuation.

Spazzatrice completamente funzionale, con cilindro a spazzola rotante. Il recipiente di raccolta è rimovibile per essere svuotato.

- rollyMinitrac
- rollyKiddy
- rollyKid
- rollyJunior
- rollyFarmtrac
- rollyFarmtrac Classic
- rollyFarmtrac Premium
- rollyX-Trac
- rollyX-Trac Premium
- rollyTruck (Unimog)

rolly[®] TracSweeper

5





Planierschild für Traktoren

Sand and snow plow for tractors

Pelle niveleuse pour tracteurs

6



7





1



- rollyMinitrac
- rollyKiddy
- rollyKid
- rollyJunior
- rollyFarmtrac
- rollyFarmtrac Classic
- rollyFarmtrac Premium
- rollyX-Trac
- rollyX-Trac Premium
- rollyTruck (Unimog)



2



1 40 932 7 rollyBackhoe

40x23x78 1,8 kg 1x

77x41,5x16,5 2,4 kg 0,053 m³



4 006485 409327

2 40 988 4 rollySweepy

49x44x40 3,1 kg 1x

52x36x26,5 3,7 kg 0,050 m³



4 006485 409884

3 40 935 8 rollyBackhoe John Deere

40x23x78 1,8 kg 1x

77x41,5x16,5 2,4 kg 0,053 m³



4 006485 409358

4 40 971 6 rollyTrac Sweeper John Deere

65x57,5x44 4,3 kg 1x

60x58,5x23 5,2 kg 0,081 m³



4 006485 409716





3



JOHN DEERE

LICENSED PRODUCT

4



- rolyMinitrac
- rolyKiddy
- rolyKid
- rolyJunior
- rolyFarmtrac
- rolyFarmtrac Classic
- rolyFarmtrac Premium
- rolyX-Trac
- rolyX-Trac Premium
- rolyTruck (Unimog)





40 918 1 rollyTrac Air Tyres

31x9,5 (4x) 6,7 kg 1x
 38,5x32x32 7,1 kg 0,039 m³



4 006485 409181



4x 310x95



Luftbereifung, 4 Stck.
pneumatic wheels, 4 pieces
pneu souples, 4 pièces
ruote gonfiabili, 4 pezzi

- rollyFarmtrac Classic
- rollyTrac (Unimog)

40 984 6 rollyTrac Air Tyres

26x9,5 (2x)
 32,5x11 (2x) 7,7 kg 1x
 43x35,5x35,5 8,3 kg 0,054 m³



4 006485 409846



2x 260x95, 2x 325x110



Luftbereifung, 4 Stck.
pneumatic wheels, 4 pieces
pneu souples, 4 pièces
ruote gonfiabili, 4 pezzi

- rollyMinitrac
- rollyKiddy
- rollyKid
- rollyJunior
- rollyFarmtrac
- rollyFarmtrac Classic
- rollyFarmtrac Premium
- rollyX-Trac
- rollyTrac (Unimog)

40 985 3 rollyTrac Air Tyres

26x9,5 (2x)
 32,5x11 (2x) 7,7 kg 1x
 43x35,5x35,5 8,3kg 0,054 m³



4 006485 409853



40 986 0 rollyTrac Air Tyres

26x9,5 (2x)
 32,5x11 (2x) 7,7 kg 1x
 43x35,5x35,5 8,3kg 0,054 m³



4 006485 409860



40 924 2 rollyTrac Air Tyres

31x9,5 (2x)
 32,5x11 (2x) 7,9 kg 1x
 43x35,5x35,5 8,5 kg 0,054 m³



4 006485 409242



2x 310x95, 2x 325x110



Luftbereifung, 4 Stck.
pneumatic wheels, 4 pieces
pneu souples, 4 pièces
ruote gonfiabili, 4 pezzi

- rollyMinitrac
- rollyKiddy
- rollyKid
- rollyJunior
- rollyFarmtrac
- rollyFarmtrac Classic
- rollyFarmtrac Premium
- rollyX-Trac
- rollyTrac (Unimog)

40 958 7 rollyTrac Air Tyres

31x9,5 (2x)
 32,5x11 (2x) 7,9 kg 1x
 43x35,5x35,5 8,5 kg 0,054 m³



4 006485 409587



40 930 3 rollyTrac Air Tyres

31x9,5 (2x)
 32,5x11 (2x) 7,9 kg 1x
 43x35,5x35,5 8,5 kg 0,054 m³



4 006485 409303











SET A: 308x98 310x95

rolyFarmtrac Classic

40 965 5 rolySnowgrip

	30,8x9,8x2		1,7 kg		1x
	22,5x14,5x10		1,8 kg		0,003 m ³



SET B: 325x110 330x120 335x120

rolyJunior
 rolyFarmtrac
 rolyFarmtrac Premium





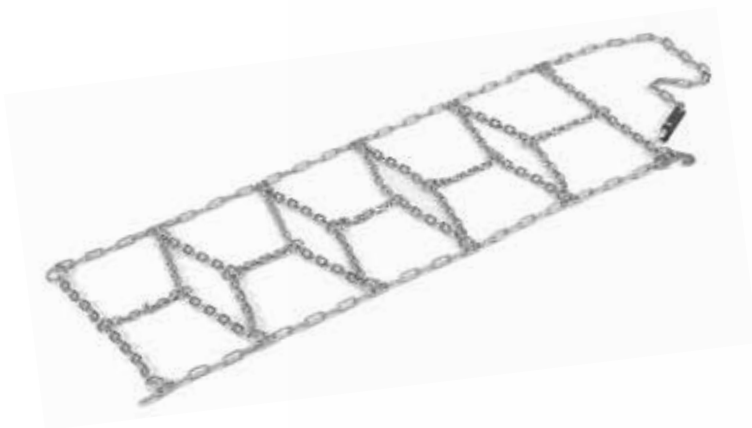

40 969 3 rolySnowgrip

	33,5x12x2		1,9 kg		1x
	22,5x14,5x10		2,0 kg		0,003 m ³



SET C: 390x150 395x150

40 966 2 rolySnowgrip

	39x15x2		2,3 kg		1x
	22,5x14,5x10		2,4 kg		0,003 m ³



rolyX-Trac
 rolyX-Trac Premium



rollyFlashlight



40 100 0 FerbedoMini Flash, blau



4 006485 401000

40 955 6 rolyFlashlight

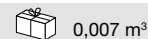
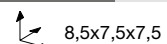

4 006485 409556



40 101 7 FerbedoMini Flash, orange



4 006485 401017

40 976 1 rolyFlashlight

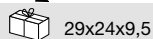
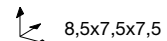

4 006485 409761



rollyBrake



40 944 0 rolyTrac Brake (rollyFarmtrac)

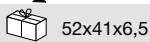

4 006485 409440

- rolyJunior
- rolyFarmtrac
- rolyFarmtrac Classic
- rolyFarmtrac Premium

40 992 1 rolyTrac Brake (rollyX-Trac)

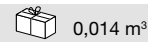
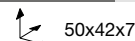

4 004099 216485

- rolyX-Trac
- rolyX-Trac Premium





rollyLight & Sound



40 959 4 rollyLight & Sound

20,4x8,4x6,4 0,8 kg 4x
 30,5x24x12,5 1,0 kg 0,009 m³



eine Lampe = drei Kombinationen
 one light = three combinations
 une lampe = trois possibilités de combinaison



rollySoundwheel

40 923 5 rollySoundwheel

20x20x9 0,4 kg 1x
 20,5x20,5x9,5 0,5 kg 0,004 m³



ohne Batterien - without batteries
 sans batterie - batterie a parte



tüüüt tüüüt
 brm brm brm

40 920 4 rollySoundwheel

20x20x9 3,2 kg VE 8x
 44x31x30 3,6 kg 0,041 m³



ohne Batterien - without batteries
 sans batterie - batterie a parte



rollyPylons

40 949 5 rollyPylons

23x13,5x13,5 3,4 kg 12x4
 44x31x30 3,8 kg 0,041 m³



4 Stk. im Set
 rolly pylons, set of 4
 Pylône rolly, Kit de 4 pièces
 Pilone rolly, 4 pz. compresi nel set



VOLVO

The VOLVO trademarks (word and device), other related trademarks, if applicable, and the Volvo designs are licensed by the AB Volvo Group



1



2

1 51 322 2 rollyDigger XL Volvo

87x45x96 12,7 kg 1x

75x26x48 14,1 kg 0,094 m³



4 006485 513222

2 51 321 5 rollyDigger XL CAT

87x45x96 12,7 kg 1x

75x26x48 14,1 kg 0,094 m³



4 006485 513215

3 42 115 2 rollyDigger Volvo

102x43x74 4,1 kg 1x

47x41,5x32 5,0 kg 0,062 m³



4 006485 421152

4 42 101 5 rollyDigger CAT

102x43x74 4,1 kg 1x

47x41,5x32 5,0 kg 0,062 m³



4 006485 421015

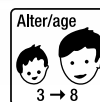



rollyDigger

3



www.cat.com / www.caterpillar.com
© 2023 Caterpillar. All Rights Reserved.
CAT, CATERPILLAR, their respective logos,
„Caterpillar Yellow“, the „Power Edge“
trade dress as well as corporate and product
identity used herein, are trademarks of Caterpillar
and may not be used without permission.
rolly toys - Franz Schneider GmbH & Co. KG,
a licensee of Caterpillar Inc.

2



4





rollyDigger



1

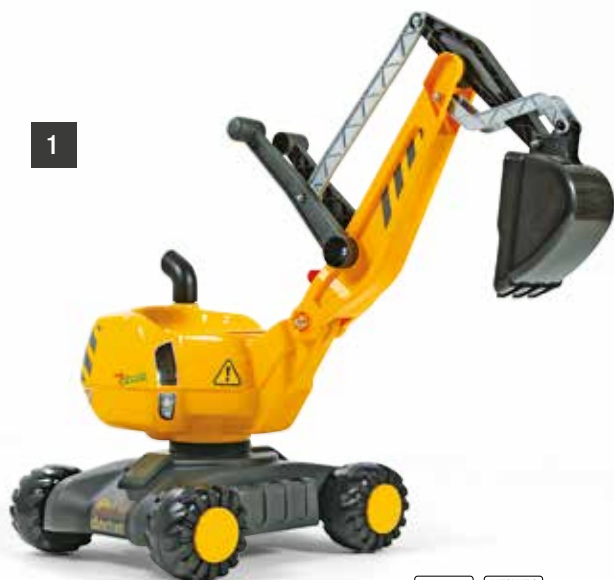

2



3



JOHN DEERE
LICENSED PRODUCT



4



1 42 100 8 rollyDigger

102x43x74 4,1 kg 1x
47x41,5x32 5,0 kg 0,062 m³



4 006485 421008

2 42 118 3 rollyDigger JCB

102x43x74 4,1 kg 1x
47x41,5x32 5,0 kg 0,062 m³



4 006485 421022

3 42 102 2 rollyDigger John Deere

102x43x74 4,1 kg 1x
47x41,5x32 5,0 kg 0,062 m³



4 006485 421022

4 42 116 9 rollyDigger Komatsu

102x43x74 4,1 kg 1x
47x41,5x32 5,0 kg 0,062 m³



4 006485 421169

KOMATSU

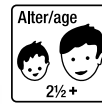

2



3



4



55 869 8
rollySafety vest

8x

0,09 m³

1 26 155 0 Kegelspiel

26x25x27 8x0,8 kg 8x

58x52x52 7,0 kg 0,157 m³



4 006485 261550

2 22 114 1 Stehaufclown

20,5x9,5x9,5 10x0,27 kg 10x

47,5x20x21,7 3,0 kg 0,021 m³



4 006485 221141

3 37 949 1 rollyShovel



4 006485 379491

4 37 950 7 rollyShovel

71x26x9 12x0,35 kg 12x

73x51x28 4,8 kg 0,104 m³



4 006485 379507

5 27 169 6 rollySchubkarre

70x30x33 1,57 kg 6x

73x31x28 2,37 kg 0,063 m³



4 006485 271696

5



1 27 184 9 rollyMetallschubkarre

 80x30x41  2,2 kg  1x
 49,5x38x13  2,7 kg  0,024 m³



2 27 175 7 rollyMetallschubkarre

 80x30x41  2,1 kg  1x
 49,5x38x13  2,6 kg  0,024 m³



3 27 181 8 rollyMetallschubkarre CAT

 80x38x41  2,0 kg  1x
 49,5x38x13  2,5 kg  0,024 m³



4 27 080 4 rollyMetallschubkarre

 80x38x41  2,0 kg  1x
 49,5x38x13  2,5 kg  0,024 m³



5 27 176 4 rollyMetallschubkarre

 80x38x41  2,0 kg  1x
 49,5x38x13  2,5 kg  0,024 m³



6 27 480 2 rollyMetallschubkarre

 80x38x41  2,0 kg  1x
 49,5x38x13  2,5 kg  0,024 m³



7 27 190 0 rollyMetallschubkarre

 80x38x41  2,0 kg  1x
 49,5x38x13  2,5 kg  0,024 m³



8 27 087 3 rollySchubkarre

 77x37x47  1,7 kg  1x
 49,5x38x13  2,0 kg  0,024 m³



9 27 085 9 rollySchubkarre

 77x37x47  1,7 kg  1x
 49,5x38x13  2,0 kg  0,024 m³



1



2



3



4

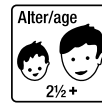

rollySommer

5



6



7



8



9



snow
SHARK



1

Carving Bob



1 20 070 2 rollySnow Shark

	103x50x18,5		3,5 kg		1x
	104,5x50x20		4,2 kg		0,105 m ³



2 20 011 5 rollySnow Max

	103x49x19		4,2 kg		1x
	104,5x50x20		4,9 kg		0,105 m ³



3 20 028 3 rollySnow Max

	103x49x19		4,2 kg		1x
	104,5x50x20		4,9 kg		0,105 m ³



4 20 027 6 rollyJetstar, Display

	93x41x22		4x2,0 kg		4x
	94x42x39		9,4 kg		0,154 m ³



5 37 949 1 rollyShovel



6 37 950 7 rollyShovel

	71x26x9		12x0,35kg		12x
	73x51x28		4,8 kg		0,104 m ³



7 20 071 9 rollyCruiserseat

	43x35x40		2,0 kg		1x
	51x26x40		2,6 kg		0,053 m ³



2



3



4



5



6



7





rollySnow Champions

JOHN DEERE

LICENSED PRODUCT



8



9



www.cat.com / www.caterpillar.com
© 2023 Caterpillar. All Rights Reserved.
CAT, CATERPILLAR, their respective logos,
„Caterpillar Yellow,“ the „Power Edge“
trade dress as well as corporate and product
identity used herein, are trademarks of Caterpillar
and may not be used without permission.
rolly toys - Franz Schneider GmbH & Co. KG,
a licensee of Caterpillar Inc.



10



11

8 20 016 0 rolySnow Cruiser John Deere

94x44x27 4,0 kg 1x
 96x45x29 4,8 kg 0,125 m³



4 006485 200160

9 20 044 3 rolySnow Cruiser CAT

94x44x27 4,0 kg 1x
 96x45x29 4,8 kg 0,125 m³



4 006485 200443

10 20 012 2 rolySnow Cruiser

94x44x27 4,0 kg 1x
 96x45x29 4,8 kg 0,125 m³



4 006485 200122

11 20 029 0 rolySnow Cruiser

94x44x27 4,0 kg 1x
 96x45x29 4,8 kg 0,125 m³



4 006485 200290



Schach, Dame • Scacchi, tria dama Échecs et de dame • Chess and draughts

21 870 7

Große Schachfiguren • big chessmen
grandes pièces d'échec • scacchi figure grande

64x24x24 2x13,6 kg 1x
101x59x49 2x16,0 kg 0,292 m³



4 006485 218707

21 891 2

Kleine Schachfiguren • small chessmen
petites pièces d'échec • scacchi figure piccole

29,5x13x13 4,7 kg 1x
64,5x39x36 5,8 kg 0,091 m³



4 006485 218912



21 871 4

Große Dame Figuren • big draughts game pieces
pions grand modèle • dama figure grande

25x25x9 13,1 kg 12x
76x51x36,5 14,5 kg 0,150m³



4 006485 218714

21 889 9

Kleine Dame Figuren • small draughts game pieces
pions petit modèle • dama figure piccole

10,5x10,5x4,5 2,0 kg 12x
38x30,5x17,5 2,2 kg 0,020 m³



4 006485 218899



21 875 2

Großes Schachfeld • large chessboard
grand échiquier • quadretto grande

36x36x1,5 18,8 kg 1x
61x41x41 19,8 kg 0,103 m³



4 006485 218752

21 895 0

Kleines Schachfeld • small chessboard
petit échiquier • quadretto piccolo

15,5x15,5x0,5 3,0 kg 1x
47,5x20x21,7 3,3 kg 0,021 m³



4 006485 218950

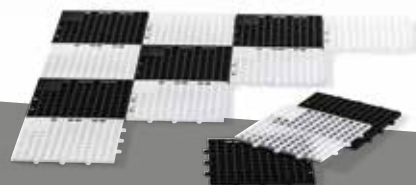
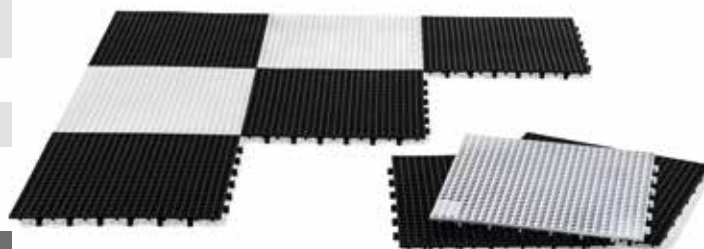



rollyOutdoor Games

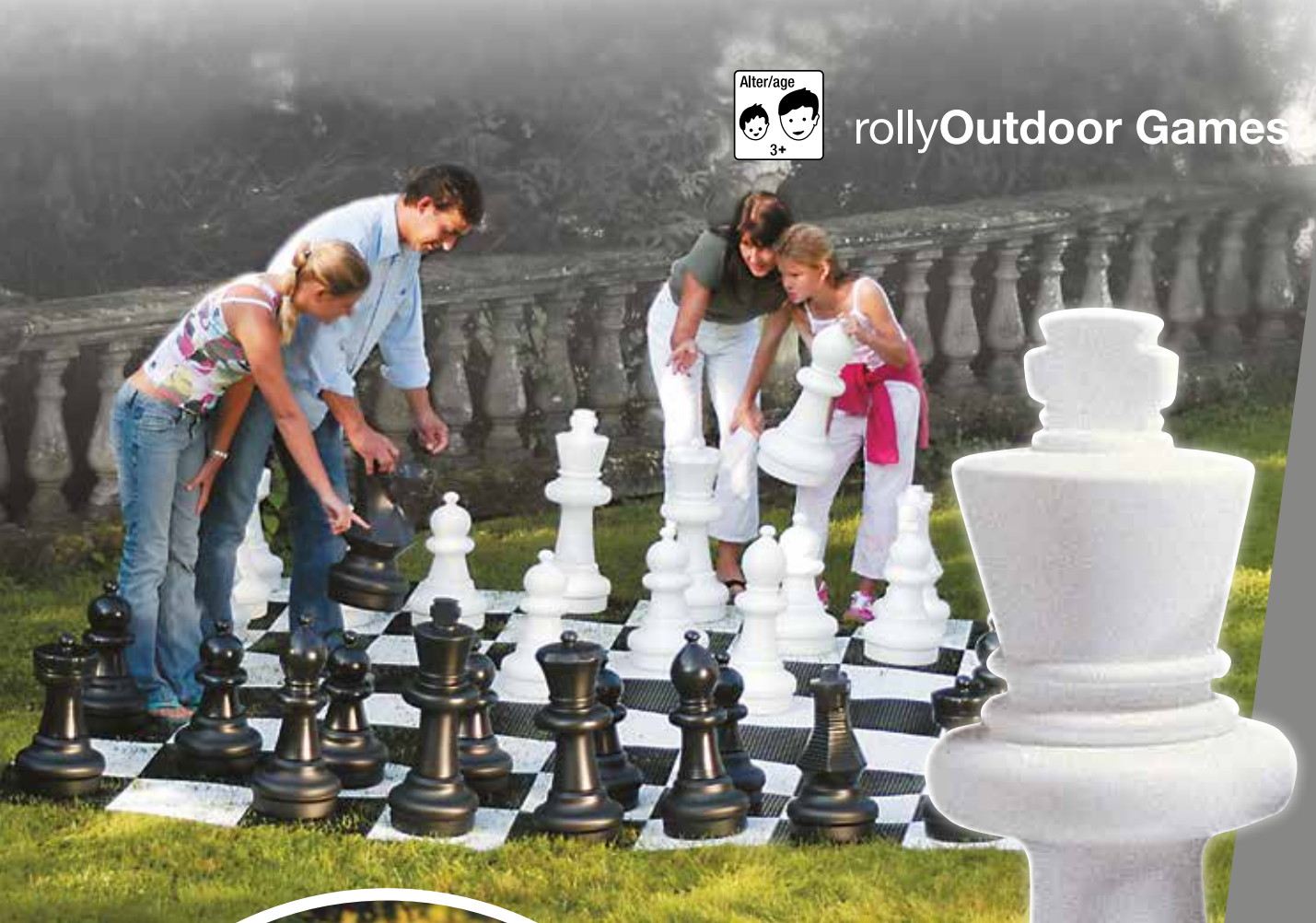

	218707	218912
	Höhe/Height (cm)	Höhe/Height (cm)
König – King	64	30
Dame – Queen	58	29
Läufer – Bishop	56	26
Pferd – Knight	48	21
Turm – Rook	43	21
Bauer - Pawn	43	20

rolly toys Quality



rolly toys Qualität zahlt sich aus!

rolly toys Funktionsspielwaren werden nach modernsten Erkenntnissen in Deutschland hergestellt und schon bei der Produktion durch die werksinterne Qualitätssicherung ständig auf Qualität und Funktionssicherheit überprüft. Zusätzlich werden die Funktionsspielzeuge nach den international verbindlichen Qualitätsstandards der europäischen Sicherheitsnorm EN 71 und teils ASTM (=US-Norm, gilt für Exportartikel nach USA) von unabhängigen Prüfinstituten getestet. Alle Funktionsspielzeuge von roly toys sind deshalb TÜV/GS zertifiziert und mit dem CE-Zeichen versehen.

Bei unseren Spielzeugen kommen nur physiologisch unbedenkliche Materialien zum Einsatz. Alle Farben, wie

auch Metallbeschichtungen, sind frei von Schwermetallen und entsprechen damit international akzeptierten Standards. In der Fertigung werden grundsätzlich umweltverträgliche Kunststoffe nach aktuellem Entwicklungsstand eingesetzt.

Durch die effektive Produktentwicklung bieten wir Ihnen ein breites, qualitativ hochwertiges und innovatives Sortiment zu einem sehr günstigen Preis-Leistungsverhältnis. Überzeugen sie sich von unserem anerkannten Lieferservice mit kurzen Lieferzeiten und sie schaffen für sich die Voraussetzung für gute Umsätze mit den in vielen Ländern bekannten und beliebten roly toys Artikeln.



La qualità roly toys vale sempre la pena!

I giocattoli funzionali roly toys vengono prodotti in Germania, in conformità alle più moderne conoscenze e controllati continuamente, già durante la produzione, dal reparto qualità dell'azienda, per quanto riguarda la qualità e la sicurezza nel funzionamento. I giocattoli funzionali vengono inoltre testati in conformità agli standard di qualità internazionali vincolanti della norma europea EN 71 ed in parte ASTM (=norma US, vale per articoli d'esportazione verso gli USA) da istituti di controllo indipendenti. Tutti i giocattoli di funzionamento della roly toys sono quindi certificati TÜV/GS e dotati di simbolo CE.

Per la produzione dei nostri giocattoli, vengono utilizzati solo materiali che non presentano rischi dal punto di vista fisiologico. Tutti i colori, come anche le coperture metalliche, sono privi di metalli pesanti e corrispondono a standard riconosciuti su scala internazionale. Per la produzione si utilizzano fundamentalmente materiali plastici che rispettano l'ambiente e che sono conformi allo stato attuale dello sviluppo.

Con l'effettivo sviluppo del prodotto Le offriamo un ampio ed innovativo assortimento, di elevato pregio qualitativo con un ottimo rapporto qualità prezzo. Si assicuri del nostro apprezzato servizio di consegna, dai brevi tempi di consegna e si assicurerà il presupposto per buoni fatturati con gli articoli roly toys conosciuti ed amati in molti paesi.



made in Germany



www.tuv.com
ID 0000960149



Publikations-Nr.: 201 4000 / 014_1-9		Seite 4 von 28 Page 1 of 28	
<p>Aufgaben: Truus Schwabe GmbH & Co. KG 66269 Rosenthal v. Giesing 07143 90700</p>			
<p>Bezeichnung der Prüfung: Funktionstest Test Name: ...</p>			
<p>Beauftragter: Truus Schwabe GmbH & Co. KG 66269 Rosenthal v. Giesing 07143 90700 07143 90701 07143 90702 07143 90703 07143 90704 07143 90705 07143 90706 07143 90707 07143 90708 07143 90709 07143 90710</p>			
<p>Abmessungen:</p>			
<p>Prüfungsort: TÜV Rheinland, USA, Products GmbH, Germany Testing location: ...</p>			
<p>Prüfungstermin:</p>			
<p>Prüfungsergebnis: Die Erprobung entspricht den geltenden Prüfverfahren. Test result: ...</p>			
<p>Prüfungskosten:</p>			
<p>gültig:</p>			
<p>Beauftragter:</p>			

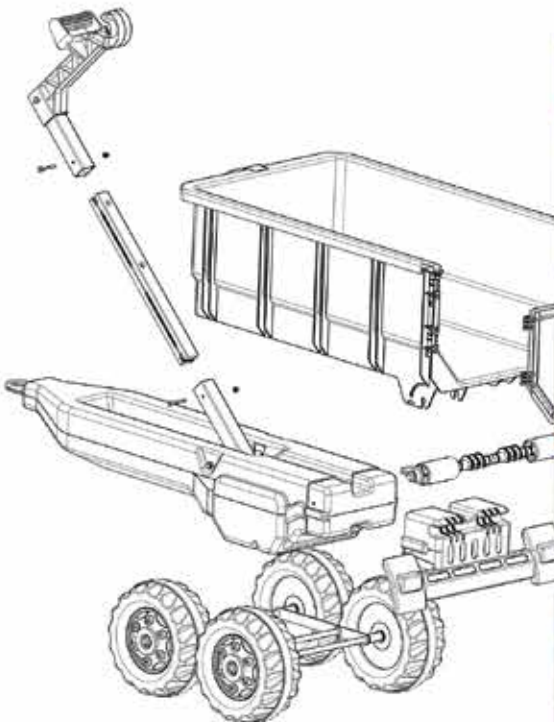

rolly toys quality pays off!

rolly toys function toys are manufactured in Germany according to the latest findings and are constantly examined, right from production, for quality and functional reliability by way of internal quality assurance. In addition, the function toys are tested by independent testing institutes in accordance with the internationally mandatory quality norms of the European safety standard EN 71 and in some cases, ASTM (=US standard, applies to export articles to the USA). Thus all function toys of roly toys are certified by the German Technical Inspection Authority (TÜV), safety tested (GS) and carry the CE mark.

Only physiologically harmless materials are used in the making of our toys. All colours as well as metal coatings are free from heavy metals and therefore meet internationally accepted standards. Only environmentally compatible plastics are used in the manufacturing process according to the current level of research.

Due to effective product development, we are able to offer you a wide, high-quality and innovative range at a very favourable price/performance ratio. Try out our accredited delivery service with short delivery times, and you will have the right base for good sales with the roly toys articles that are famous and popular in many countries.



La qualité roly toys en vaut la peine!

Les jouets fonctionnels roly toys sont fabriqués en Allemagne selon les acquis les plus modernes et constamment réexaminés dès la production par l'assurance qualité interne du producteur en ce qui concerne la qualité et la sécurité de fonctionnement. De plus, les jouets fonctionnels sont testés au niveau international par des instituts de contrôle indépendants selon les normes de qualité obligatoires de la norme de sécurité EN Européenne 71, et en partie également de la norme US ASTM pour les articles d'exportation vers les USA. Tous les jouets fonctionnels roly toys sont par conséquent certifiés par le service des Mines allemand et livrés avec le sigle CE.

Seuls des matériaux physiologiquement inoffensifs sont utilisés pour nos jouets. Toutes les teintes et les revêtements métallisés sont libres de métaux lourds et correspondent ainsi au niveau international aux normes admises. Seules les matières plastiques systématiquement écologiques sont utilisées dans la fabrication selon le niveau actuel de la recherche.

De par notre développement effectif de produit, nous vous offrons un large assortiment de grande qualité et innovateur pour un rapport performance/prix très favorable. Faites la preuve de notre service livraison éprouvé avec courts délais de livraison et vous créez la condition d'excellents chiffres d'affaires grâce aux articles roly toys populaires dans de nombreux pays.



Art.Nr	Bezeichnung	Seite	Art.Nr	Bezeichnung	Seite	Art.Nr	Bezeichnung	Seite
rollyKid			12 210 3	rollyFarm Trailer John Deere	72	rollySnow Champions		
01 184 1	rollyKid Landini Power Farm 100, rolyKid Trailer	24	12 212 7	rollyTanker silber, Zweiachser	68	20 011 5	rollySnowMax rot	92
01 212 1	rollyKid-X, rolyKid Trailer	16	12 215 8	rollyTimber Trailer, Zweiachskipper, grün	71	20 012 2	rollySnowCruiser rot	93
01 215 2	rollyKid Zetor Forterra 135	20	12 216 5	rollyHalfpipe John Deere	64	20 016 0	rollySnowCruiser John Deere	93
01 216 9	rollyKid-X, rolyKid Trailer	17	12 220 2	rollyMega Trailer grün	62	20 027 6	rollyJetstar, Display	92
01 219 0	rollyKid John Deere, rolyKid Trailer	25	12 221 9	rollyHalfpipe CLAAS	65	20 028 3	rollySnowMax blau	92
01 230 5	rollyKid MF, rolyKid Trailer	20	12 224 0	rollyHalfpipe Deutz-Fahr	64	20 029 0	rollySnowCruiser blau	93
01 241 1	rollyKid Case CVX1170, rolyKid Trailer	20	12 226 4	rollyHalfpipe Joskin	67	20 044 3	rollySnow Cruiser CAT	93
01 251 0	rollyKid Steyr 6165 CVT, rolyKid Trailer	22	12 247 9	rollyHaywagon Pöttinger	71	20 070 2	rollySnowShark	92
01 252 7	rollyKid Valtra, rolyKid Trailer	24	12 265 3	rollyTanker grün, Zweiachser	68	20 071 9	rollyCruiserseat	92
01 261 9	rollyKid JCB, rolyKid Trailer	26	12 275 2	rollyTanker John Deere, Zweiachser, rolyPompa	69	rollyOutdoor Games		
01 307 4	rollyKid NewHolland T 7040, rolyKid Trailer	23	12 277 6	rollyTanker silber, rolyPompa	68	21 870 7	rollySchachfiguren	94
01 316 6	rollyKid Fendt Vario 516, rolyKid Trailer	21	12 286 8	rollyVacumax grün, rolyPompa	69	21 871 4	rollyDamesteine	94
01 494 1	rollyKid Little Grey Fergie	19	12 296 7	rollyFire rot, rolyPompa	69	21 875 2	rollySchachfeld	94
<hr/>			12 298 1	rollyHay Wagon grün, Einachskipper	71	21 889 9	rollyDamesteine	94
02 311 0	rollyKid John Deere, rolyKid Lader, rolyKid Trailer	25	12 301 8	rollyMega Trailer rot	63	21 891 2	rollySchachfiguren	94
02 312 7	rollyKid-X, rolyKid Lader, rolyKid Trailer rot	16	12 319 3	rollyHalfpipe Single	64	21 895 0	rollySchachfeld	94
02 313 4	rollyKid-X, rolyKid Lader, rolyKid Trailer grün	17	12 320 9	rollyMulti Trailer Joskin	67	rollyClassic Summer		
02 319 6	rollyKid Deutz 5115 G TB, rolyKid Lader, rolyKid Trailer	19	12 322 3	rollyContainer Krampe	67	22 114 1	Stehaufclown, Glockensound	89
02 328 8	rollyKid CAT, rolyKid Lader, rolyKid Trailer	27	12 323 0	rollyHalfpipe Krampe	65	26 155 0	Kegelspiel	89
02 383 7	rollyKid JCB, rolyKid Lader, rolyKid Trailer	26	12 326 1	rollyHalfpipe Krampe, HP 20, schwarz	65	27 080 4	Metallschubkarre rot	90
02 392 9	rollyKid New Holland T 7040, rolyKid Lader, rolyKid Trailer	23	12 381 0	rollyFarm Roller	74	27 085 9	Schubkarre gelb/rot, Metall/Kunststoff	91
02 393 6	rollyKid Steyr 6165 CVT, rolyKid Lader, rolyKid Trailer	22	12 384 1	rollyCambridge	74	27 087 3	Schubkarre grün/gelb, Metall/Kunststoff	91
02 417 9	rollyDumperKid CAT	27	12 386 5	rollyScraper	74	27 169 6	rollySchubkarre	89
02 424 7	rollyDumperKid JCB	26	12 393 3	rollyContainer, Trailer mit zwei Containern	66	27 175 7	Metallschubkarre, Luftbereifung	90
02 507 7	rollyKid Claas Elios	21	12 500 5	rollyMulti Trailer grün, Zweiachskipper	61	27 176 4	rollySchubkarre silber/blau	91
<hr/>			12 501 2	rollyMulti Trailer grün, Dreiachskipper	60	27 181 8	Metallschubkarre CAT	90
rollyTrucks			12 504 3	rollyMulti Trailer John Deere, Dreiachskipper	60	27 184 9	Metallschubkarre, Doppelbereifung	90
03 822 0	rollyUnimog Fire, rolyBrake, Schaltung	54	12 509 8	rollyContainer John Deere	66	27 190 0	Metallschubkarre grün	91
03 823 7	rollyUnimog Service	54	12 510 4	rollyStreumax Amazone	73	27 480 2	Metallschubkarre pink	91
03 824 4	rollyUnimog Forst, rolyPowerwinch	55	12 511 1	rollyStreumax Trailer John Deere	73	37 949 1	rollySchneeschaufel grün	89
03 825 1	rollyUnimog Polizei	55	12 881 5	rollyKipper II rot	70	37 950 7	rollySchneeschaufel rot	89
04 669 0	rollyFarmtrac MB, rolyTrac Lader, Schaltung, rolyBrake	38	12 882 2	rollyKipper II John Deere	70	rollyAccessories		
<hr/>			12 884 6	rollyKipper II blau	70	40 100 0	Ferbedo Mini Flash blau	84
rollyDreiradtrac			12 885 3	rollyKipper II Claas	70	40 101 7	Ferbedo Mini Flash orange	84
05 276 9	rollyTrac John Deere, Soundwheel, rolyKid Trailer	25	rollyMinitrac			40 889 4	rollyBox rolyMilk Churns	75
05 293 6	rollyTrac CAT, Soundwheel, rolyKid Trailer	27	13 201 0	rollyMinitrac Steyr 4115 Multi	10	40 892 4	rollyBox Claas	75
<hr/>			13 207 2	rollyMinitrac John Deere 6150R	11	40 893 1	rollyBox grün/gelb	75
rollyTrailer			13 208 9	rollyMinitrac NH T6010	10	40 894 8	rollyBox silber/rot	75
12 110 6	rollyMega Trailer blau	62	13 210 2	rollyMinitrac Deutz-Fahr Agrokid 230	13	40 895 5	rollyTrac Lader Premium	77
12 150 2	rollyMega Trailer grün	62	13 214 0	rollyMinitrac Dumper	12	40 896 2	rollyTrac Lader Premium black	77
12 171 7	rollyKid Trailer rot	72	13 224 9	rollyMinitrac CAT Dumper	12	40 898 6	rollyPowerwinch grün	78
12 172 4	rollyKid Trailer grün	72	13 226 3	rollyMinitrac Case CVX 165	10	40 899 3	rolly Snowmaster grün	79
12 174 8	rollyKid Trailer grün	72	13 233 1	rollyMinitrac MF 5470	10	40 900 6	rollyPowerwinch gelb	78
12 176 2	rollyKid Trailer blau	72	13 239 3	rollyMinitrac Valtra	13	40 918 1	rollyAir Tyres für Trakt. 4 x 310x95 silber	82
12 200 4	rollyMega Trailer grün	63	13 242 3	rollyMinitrac Carabella	14	40 920 4	rollySoundlenkrad = 8x 409235	85
12 202 8	rollyMinitrac Trailer John Deere	11	13 256 0	rollyMinitrac rolyMinitrac Trailer	14	40 923 5	rollySoundlenkrad	85
12 208 0	rollyMinitrac Trailer rot	13	13 265 2	rollyMinitrac Claas Xerion	11	40 924 2	rollyLuftbereifung für Trakt. 2 x 310x95, 2 x 325x110 silber	82
12 209 7	rollyFarm Trailer rot/silber	72	13 277 5	rollyMinitrac Lindner	13	40 928 0	rollyPowerwinch schwarz	78
<hr/>			13 564 6	rollyMinitrac JCB Dumper	12	40 930 3	rollyLuftbereifung für Trakt. 2 x 310x95, 2 x 325x110 gelb	82
<hr/>			rollyMiniTruck			40 931 0	rollyKid Lader silber	76
<hr/>			16 100 3	rollyMiniTruck Mack	15	40 932 7	rollyHeckbagger rot	80
<hr/>			16 101 0	rollyMiniTruck Mack	15	40 933 4	rollyJunior Lader silber	76

Artikelliste

Art.Nr	Bezeichnung	Seite	Art.Nr	Bezeichnung	Seite	Art.Nr	Bezeichnung	Seite
40 934 1	rollyTrac Lader schwarz	76	61 108 9	rollyFarmtrac Fendt 211 Vario, rollyTrac Lader, rollyTrac Air Tyres	33	72 003 3	rollyFarmtrac Premium II Valtra	51
40 935 8	rollyHeckbagger John Deere	81	61 109 6	rollyFarmtrac John Deere 6210R, rollyTrac Lader	39	72 005 7	rollyFarmtrac Premium II Deutz 8280 TTV	44
40 938 9	rollyMilk Churns (4 Stück)	75	61 110 2	rollyFarmtrac John Deere 6210R, rollyTrac Lader, rollyTrac Air Tyres	39	72 006 4	rollyFarmtrac Premium II CLAAS Arion 640	41
40 939 6	rollyTrac Lader	76	61 112 6	rollyFarmtrac Case Puma CVX 240, rollyTrac Lader, rollyTrac Air Tyres	36	72 007 1	rollyFarmtrac Premium II Lintrac	52
40 940 2	rollyPompa	69	61 113 3	rollyFarmtrac MF 8650, rollyTrac Lader	32	73 000 1	rollyFarmtrac Premium II Steyr 6300 Terrus CVT, rollyTrac Lader	42
40 944 0	rollyBrake (rollyFarmtracs)	84	61 114 0	rollyFarmtrac MF 8650, rollyTrac Lader, rollyTrac Air Tyres	32	73 002 5	rollyFarmtrac Premium II Steyr 6300 Terrus CVT, rollyTrac Lader, rollyTrac Air Tyres	43
40 949 5	rollyPylone (Set = 4 Stück)	85	61 120 1	rollyFarmtrac Deutz-Fahr 5125, rollyTrac Lader	34	73 003 2	rollyFarmtrac Premium II John Deere 7310R, rollyTrac Lader	49
40 955 6	rollyFlashlight orange = 4 x 40 978 5	84	61 121 8	rollyFarmtrac Deutz-Fahr 5125, rollyTrac Lader, rollyTrac Air Tyres	34	73 005 6	rollyFarmtrac Premium II Valtra, rollyTrac Lader	51
40 958 7	rollyLuftbereifung für Trakt. 2 x 310x95, 2 x 325x110 rot	82	61 125 6	rollyFarmtrac New Holland T7, rollyTrac Lader	37	73 008 7	rollyFarmtrac Premium II Deutz 8280 TTV, rollyTrac Lader	44
40 959 4	rollyLight & Sound	85	61 127 0	rollyFarmtrac New Holland T7, rollyTrac Lader, rollyTrac Air Tyres	37	73 009 4	rollyFarmtrac Premium II Deutz, rollyTrac Lader, rollyTrac Air Tyres	45
40 961 7	rollySnow Master	79	350 000 0	rollyKiddy Futura, rollyKid Trailer	18	73 010 0	rollyFarmtrac Premium II CLAAS Arion 640, rollyTrac Lader	41
40 963 1	rollyRundholz (Set = 6 Stück)	71	350 003 5	rollyKiddy Futura, rollyKid Trailer, rollyKid Lader	18	73 011 7	rollyFarmtrac Premium II Lintrac, rollyTrac Lader	52
40 965 5	rollySnowgrip 2 Stck. für Rad 308x98	83	350 004 2	rollyKiddy Classic, rollyKid Trailer, rollyKid Lader	19	73 014 8	rollyFarmtrac Premium II Deutz Warrior Agrotron 8280 TTV, rollyTrac Lader	NEU 47
40 966 2	rollySnowgrip 2 Stck. für Rad 390x150	83	350 008 5	rollyKiddy Futura, rollyKid Trailer, rollyKid Lader	18	350 000 0	rollyKiddy Futura, rollyKid Trailer	18
40 967 9	rollyTimber Loader, Anbausatz	77	350 003 5	rollyKiddy Futura, rollyKid Trailer, rollyKid Lader	18	350 004 2	rollyKiddy Classic, rollyKid Trailer, rollyKid Lader	19
40 969 3	rollySnowgrip 2 Stck. für Rad 335x120	83	350 008 5	rollyKiddy Futura, rollyKid Trailer, rollyKid Lader	18	350 004 2	rollyKiddy Classic, rollyKid Trailer, rollyKid Lader	19
40 970 9	rollyTrac Sweeper	78	350 008 5	rollyKiddy Futura, rollyKid Trailer, rollyKid Lader	18	350 004 2	rollyKiddy Classic, rollyKid Trailer, rollyKid Lader	19
40 971 6	rollyTrac Sweeper John Deere	81	350 008 5	rollyKiddy Futura, rollyKid Trailer, rollyKid Lader	18	350 004 2	rollyKiddy Classic, rollyKid Trailer, rollyKid Lader	19
40 972 3	rollySweepy orange	78	350 008 5	rollyKiddy Futura, rollyKid Trailer, rollyKid Lader	18	350 004 2	rollyKiddy Classic, rollyKid Trailer, rollyKid Lader	19
40 976 1	rollyFlashlight blau = 4x 40 975 4	84	350 008 5	rollyKiddy Futura, rollyKid Trailer, rollyKid Lader	18	350 004 2	rollyKiddy Classic, rollyKid Trailer, rollyKid Lader	19
40 984 6	rollyTrac Air Tyres für Trakt. 2 x 260x95, 2 x 325x110, silber	82	350 008 5	rollyKiddy Futura, rollyKid Trailer, rollyKid Lader	18	350 004 2	rollyKiddy Classic, rollyKid Trailer, rollyKid Lader	19
40 985 3	rollyTrac Air Tyres für Trakt. 2 x 260x95, 2 x 325x110, rot	82	350 008 5	rollyKiddy Futura, rollyKid Trailer, rollyKid Lader	18	350 004 2	rollyKiddy Classic, rollyKid Trailer, rollyKid Lader	19
40 986 0	rollyTrac Air Tyres für Trakt. 2 x 260x95, 2 x 325x110, gelb	82	350 008 5	rollyKiddy Futura, rollyKid Trailer, rollyKid Lader	18	350 004 2	rollyKiddy Classic, rollyKid Trailer, rollyKid Lader	19
40 988 4	rollySweepy grün	80	350 008 5	rollyKiddy Futura, rollyKid Trailer, rollyKid Lader	18	350 004 2	rollyKiddy Classic, rollyKid Trailer, rollyKid Lader	19
40 992 1	rollyBrake (rollyX-Trac)	84	350 008 5	rollyKiddy Futura, rollyKid Trailer, rollyKid Lader	18	350 004 2	rollyKiddy Classic, rollyKid Trailer, rollyKid Lader	19
rollyDigger Kunststoff			rollyKiddy			rollyJunior		
42 100 8	rollyDigger	88	62 000 5	rollyKiddy Futura, rollyKid Trailer	18	80 026 1	rollyJunior RT rot, rollyFarm Trailer	28
42 101 5	rollyDigger CAT	87	63 003 5	rollyKiddy Futura, rollyKid Trailer, rollyKid Lader	18	81 107 6	rollyJunior John Deere, rollyJunior Lader, rollyHeckbagger	30
42 102 2	rollyDigger John Deere	88	63 004 2	rollyKiddy Classic, rollyKid Trailer, rollyKid Lader	19	81 139 7	rollyJunior RT rot, rollyJunior Lader, rollyFarm Trailer	29
42 115 2	rollyDigger Volvo	87	350 008 5	rollyKiddy Futura, rollyKid Trailer, rollyKid Lader	18	81 146 5	rollyJunior RT grün, rollyJunior Lader	28
42 116 9	rollyDigger Komatsu	88	350 008 5	rollyKiddy Futura, rollyKid Trailer, rollyKid Lader	18	81 200 4	rollyJunior JCB, rollyJunior Lader, rollyHeckbagger	31
42 118 3	rollyDigger JCB	88	350 008 5	rollyKiddy Futura, rollyKid Trailer, rollyKid Lader	18	81 300 1	rollyJunior CAT, rollyJunior Lader, rollyHeckbagger	30
rollyDigger Metall			rollyX-Trac Premium			rollyTruck		
51 321 5	rollyDigger XL CAT	86	64 003 4	rollyX-Trac Premium, John Deere 8400 R	56	88 100 0	rollyTruck Volvo	53
51 322 2	rollyDigger XL Volvo	86	64 008 9	rollyX-Trac Premium CLAAS Axion 940	58			
Farmers' Shop			65 100 9	rollyX-Trac Premium, rollyTrac Lader Premium	59			
55 869 8	rollySafety vest	89	65 101 6	rollyX-Trac Premium, rollyTrac Lader Premium, Schaltung, rollyTrac Brake	59			
rollyFarmtrac			65 104 7	rollyX-Trac Premium John Deere 8400 R, rollyTrac Lader Premium	56			
60 102 8	rollyFarmtrac Fendt 211 Vario	33	65 107 8	rollyX-Trac Premium, John Deere 8400 R rollyTrac Lader P., Schaltung, rollyTrac Brake	57			
60 104 2	rollyFarmtrac Claas Axos 340	40	65 109 2	rollyX-Trac Premium CLAAS Axion 950, rollyTrac Lader Premium	58			
60 105 9	rollyFarmtrac Case Puma CVX 240	36	65 112 2	rollyX-Trac Premium CLAAS Axion 960, rollyTrac Lader P., Schaltung, rollyTrac Brake	58			
60 106 6	rollyFarmtrac John Deere 6210R	38	350 008 5	rollyKiddy Futura, rollyKid Trailer, rollyKid Lader	18			
60 115 8	rollyFarmtrac MF 8650	32	350 008 5	rollyKiddy Futura, rollyKid Trailer, rollyKid Lader	18			
60 124 0	rollyFarmtrac Deutz-Fahr 5125	34	350 008 5	rollyKiddy Futura, rollyKid Trailer, rollyKid Lader	18			
60 129 5	rollyFarmtrac New Holland T7	37	350 008 5	rollyKiddy Futura, rollyKid Trailer, rollyKid Lader	18			
61 100 3	rollyFarmtrac JCB 8250, rollyTrac Lader	35	350 008 5	rollyKiddy Futura, rollyKid Trailer, rollyKid Lader	18			
61 104 1	rollyFarmtrac Claas Axos 340, rollyTrac Lader	40	350 008 5	rollyKiddy Futura, rollyKid Trailer, rollyKid Lader	18			
61 105 8	rollyFarmtrac Fendt 211 Vario, rollyTrac Lader	33	350 008 5	rollyKiddy Futura, rollyKid Trailer, rollyKid Lader	18			
61 106 5	rollyFarmtrac Case Puma CVX 240, rollyTrac Lader	36	350 008 5	rollyKiddy Futura, rollyKid Trailer, rollyKid Lader	18			
			350 008 5	rollyKiddy Futura, rollyKid Trailer, rollyKid Lader	18			

Es gelten unsere allgemeinen Lieferbedingungen auf der Preisliste. Technische Änderungen und Farbänderungen bleiben vorbehalten.

Our general delivery conditions written on the price list are valid. All rights are reserved to make any technical modifications and colour changes.

Nous appliquons les conditions de livraison indiquées sur nos tarifs. Sous réserve de modifications techniques et de changements de teintes.

Sono valide tutte le condizioni scritte riportate a listino. Ci riserviamo tutti i diritti di apportare modifiche tecniche e cambiamenti di colore

Vertretungen national

National representative • Représentations nationales • rappresentanti nazionali

Auftragsannahme Neustadt: FAX + 49 (0) 9568-856195, inland@rollytoys.de

Bert Stoklossa Industriervertretungen

Bert Stoklossa
Missionsweg 18, 21220 Seevetal
Fon 04185 - 792022 • Fax 04185 - 792023
E-Mail: bert@stoklossa-iv.de

Handelsagentur Paus

Norbert Paus
Wernerstr. 20, 46399 Bocholt
Fon 02871 - 48530
Fax 02871 - 487330
E-Mail: norbert@ha-paus.de

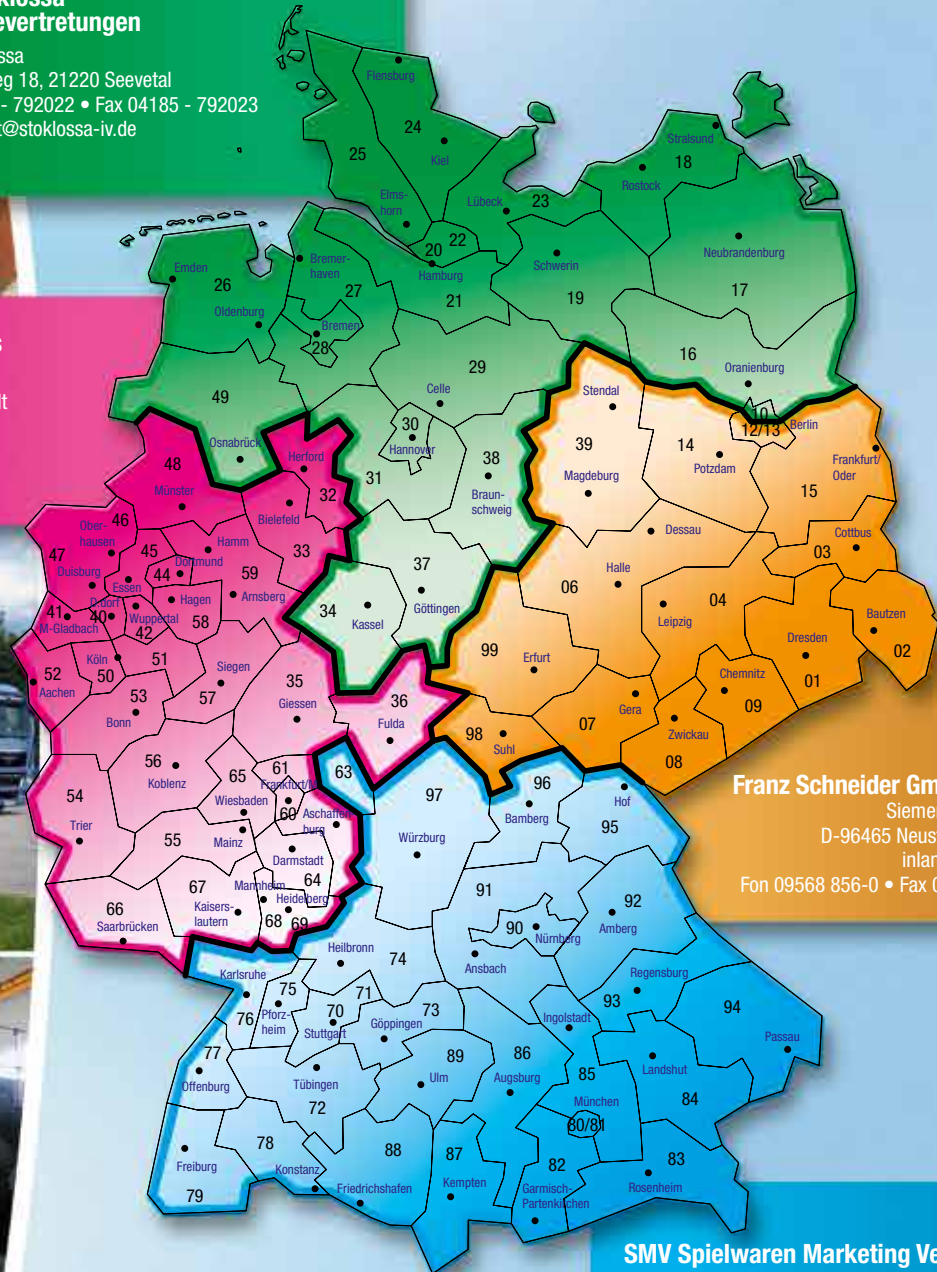

Franz Schneider GmbH & Co. KG
Siemensstraße 13-19
D-96465 Neustadt bei Coburg
inland@rollytoys.de
Fon 09568 856-0 • Fax 09568 856-195

SMV Spielwaren Marketing Vertrieb Reinhard Simon & Bernd Markmiller OHG

Reinhard Simon, Bernd Markmiller
Alexander Rieger, Renate Eibich
Dieselstr. 25, 86368 Gersthofen
Fon 0821 - 780851-0 • Fax 0821 - 780851-10
E-Mail: office@smv-spielwaren.de



Die Marke für Kinderfahrzeuge

The brand for children's vehicles
La marque de véhicules pour enfants
La marca di veicoli per bambini

*...hat das Zeug
zum Spielen*



Franz Schneider GmbH & Co. KG

■ made
■ in
■ Germany

2023

FERBEDO[®]

 made
in
Germany

Franz Schneider GmbH & Co. KG

FERBEDO®



Die Tradition der Ferdinand Bethäuser GmbH & Co. KG reicht bis ins Gründungsjahr 1898 zurück. Seit 1914 produzierte das bis zur Insolvenz 2018 Inhaber geführte Familien-unternehmen Kinderfahrzeuge.

Frank Schneider, geschäftsführender Gesellschafter der Franz Schneider GmbH & Co. KG erkannte die Potenziale, die sich aus einem Zusammenführen der zwei Traditions-marken roolly toys und Ferbedo unter einem Dach ergeben könnten.

Seit 2020 gehört die Marke Ferbedo zur Franz Schneider GmbH & Co. KG. Sie wird als Marke mit einem eigenen, ergänzenden Sortiment weiterleben und schon allein durch die sich daraus ergebenden Synergie-effekte wieder eine Zukunft haben.

The tradition of Ferdinand Bethäuser GmbH & Co. KG goes back to the year it was founded in 1898. The owner-lead family company produced children's vehicles from 1914 up until it went insolvent in 2018.

Frank Schneider, managing director of Franz Schneider GmbH & Co. KG, recognised the potential in bringing the two traditional brands of roolly toys and Ferbedo under one roof.

The brand Ferbedo has been part of Franz Schneider GmbH & Co. KG since 2020. It lives on as a brand with its own range of products and will have a future again thanks purely to the resulting synergistic effects.



La tradition de Ferdinand Bethäuser GmbH & Co. KG remonte à l'année de sa fondation en 1898. Depuis 1914, l'entreprise familiale qui a été gérée par son propriétaire jusqu'à son insolvabilité en 2018 produit des véhicules pour enfants.

Frank Schneider, associé gérant de Franz Schneider GmbH & Co. KG a reconnu le potentiel qui pourrait résulter de la réunion des deux marques traditionnelles roly toys et Ferbedo sous un même toit.

Depuis 2020, la marque Ferbedo fait partie de la société Franz Schneider GmbH & Co. KG. Elle continuera à vivre en tant que marque avec sa propre gamme de produits complémentaires et aura à nouveau un avenir simplement grâce aux effets de synergie qui en résulteront.



La tradizione della Ferdinand Bethäuser GmbH & Co. KG risale al 1898, anno della fondazione. Dal 1914 fino all'insolvenza nel 2018, l'azienda familiare gestita dal titolare produceva veicoli per bambini.

Frank Schneider, amministratore delegato della Franz Schneider GmbH & Co. KG ha intuito i potenziali che potevano derivare unendo i dei due marchi tradizionali roly toys e Ferbedo sotto uno stesso tetto.

Dal 2020 il marchio Ferbedo appartiene alla Franz Schneider GmbH & Co. KG. Continuerà a vivere come marchio con un proprio assortimento integrativo e gli effetti sinergici che ne derivano le garantiranno un nuovo futuro.

FERBEDO® Franz Schneider GmbH & Co. KG

Postfach 1460
D-96465 Neustadt bei Coburg
Germany
Tel.: 09568 / 856-0
Fax: 09568 / 856-190
E-Mail: info@rollytoys.de
www.rollytoys.de

Werk I - Verwaltung
Siemensstraße 13-19
D-96465 Neustadt bei Coburg
Germany

Werk II - Versand + Warenannahme
Franz-Schneider-Straße 1
D-96465 Neustadt bei Coburg
Germany

Erläuterungen Explanations Explications Informazioni

Die Bildunterschriften zu den Artikeln enthalten Angaben zu Artikelgröße (LxBxH), Artikelgewicht, Verpackungsgröße (LxBxH), Verpackungsgewicht, -volumen, und -einheit. Die von der Franz Schneider GmbH & Co. KG produzierten Ferbedo Artikel entsprechen der EU Norm EN 71. Alle Ferbedo-Kinderfahrzeuge sind TÜV/GS geprüft und CE gekennzeichnet. Technische Änderungen, Farbänderungen und Änderungen im Design bleiben vorbehalten. Die Artikel werden teilmontiert ausgeliefert, die Endmontage darf nur von Erwachsenen ausgeführt werden. Entsprechend gekennzeichnete Artikel sind mit der 3-Jahres Pro Stabil Garantie versehen.

The captions for the products contain information regarding product dimensions (LxWxH), product weight, packaging dimensions (LxWxH), packaging weight, volume and unit. The Ferbedo products produced by Franz Schneider GmbH & Co. KG comply with European standard EN 71. All Ferbedo children's vehicles are TÜV/GS tested and bear the CE mark. Subject to change, colour alterations and design modifications. The products are delivered partially assembled. Final assembly should only be carried out by an adult. Accordingly-marked products come with the 3-year Pro Stabil guarantee.

Les légendes des articles contiennent des informations sur la taille de l'article (lxLxh), le poids de l'article, la taille de l'emballage (lxLxh), son volume et son unité. Les articles Ferbedo fabriqués par Franz Schneider GmbH & Co. KG sont conformes à la norme UE EN 71. Tous les véhicules pour enfants de Ferbedo sont testés par TÜV-GS et marqués CE. Nous nous réservons le droit d'apporter des modifications techniques, des modifications de couleurs et des modifications de design. Les articles sont livrés partiellement assemblés, le montage final ne peut être effectué que par des adultes. Les articles avec la marque correspondante sont fournis avec la garantie Pro Stabil de 3 ans.

Le didascalio degli articoli contengono informazioni sulla dimensione e peso degli articoli (LxPxH), su dimensioni e peso della confezione (LxPxH), volume e unità della confezione. Gli articoli Ferbedo prodotti dalla Franz Schneider GmbH & Co. KG sono conformi alla norma UE EN 71. Tutti i veicoli per bambini Ferbedo sono testati TÜV/GS e certificati CE. Sono fatte salve modifiche tecniche, cambiamenti di colore e variazioni del design. Gli articoli vengono forniti parzialmente montati; il montaggio finale può essere eseguito unicamente da persone adulte. Gli articoli con relativo contrassegno sono dotati della garanzia Pro Stabil di 3 anni.

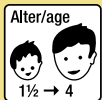
 Altersangabe als Empfehlung
Recommended age
Indication d'âge purement indicative
Indicazione età consigliata

 Garantie
Guarantee
Garantie
Garanzia

 Sitzverstellung
Seat shift
Déplacement du siège
Sella regolabile

 Handbremse
Hand-brake
Frein à main
Freno a mano

 Flüsterreifen
Noiseless tyres
Pneus silencieux
Ruote silenziose

 Luftbereifung
Pneumatic wheel
Pneu souples
Ruote gonfiabili

 Maximale Belastbarkeit
Maximum loading capacity
Capacité maximale
Portata massima

 Neuheit
New item
Nouveauté
Novità

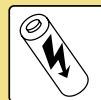
 Batteriebetrieb
Battery-operated
Modèle avec batterie et chargeur fournis
Funziona a batteria

 Hupe
Horn
Klaxon
Clacson

 Kettenschutz
Protected Chain
Chaîne protégée
Cingolo protetto



 made
in
Germany



Das Tragen von Schutzausrüstung wird dringend empfohlen
It is strongly recommended to wear protective gear
Il est fortement recommandé d'utiliser des équipements de protection
Si consiglia di indossare un equipaggiamento protettivo

Übersicht Größen



ca. 68 -134 cm



ca. 104 -134 cm
ca. 110 -140 cm

Inhalt Contents Sommaire Indice

Editorial	02 - 03
Erläuterungen, Explanations Explications, Informationi	04
Inhaltverzeichnis	05
Neuheit, New, Nouveauté, Novita	06
Index	07
Ferbedo Trucks	08-10
Ferbedo Tigerente	11
Ferbedo Gokarts	12 - 13



Die Spielwaren sind nur unter Aufsicht von Erwachsenen zu verwenden. Allgemeine Gefahren- und Gebrauchshinweise sind unbedingt zu beachten.

The toys are only to be used under adult supervision. General danger and usage notices must be unconditionally observed.

Les jouets doivent être utilisés sous la surveillance d'adultes. Les prescriptions de danger et les prescriptions d'utilisation doivent être impérativement respectées.

I giocattoli possono essere utilizzati solo sotto la supervisione di un adulto. Le istruzioni generali per l'uso e le avvertenze di pericolo devono essere rispettate rigorosamente.

Nationale und internationale Vertretungen siehe im rolly toys Katalog Seite 100-101

For national and international agencies, see rolly toys catalogue page 100-101

Pour les agences nationales et internationales, voir la page 100-101 du catalogue rolly toys

Per le rappresentanze nazionali e internazionali vedere pagina 100-101 del catalogo rolly toys.



 made
 in
 Germany

Ferbedo Gokarts

10 400 0	Ferbedo Gokart X-Racer	13
10 500 7	Ferbedo Gokart AT X-Racer	13
10 501 4	Ferbedo Gokart Air Runner	13

11 200 5	Ferbedo Gokart AR 8G	12
11 201 2	Ferbedo Gokart AR 8R	12

Ferbedo Rutscher

15 000 7	Ferbedo Tigerente	11
----------	-------------------	----

Ferbedo Truck

17 110 1	Ferbedo Truck Polizei	08
17 112 5	Ferbedo Truck Feuerwehr	09
17 119 4	Ferbedo Truck Racing	08
17 123 1	Ferbedo Truck Service	08
17 200 9	Ferbedo Truck BIO, grün	10
17 201 6	Ferbedo Truck BIO, blau	10

Ferbedo Accessories

40 100 0	Ferbedo Mini Flash, blau	10
40 101 7	Ferbedo Mini Flash, orange	10





1

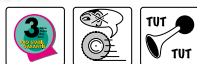
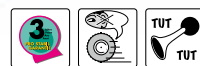

3



1 17 110 1 Ferbedo Truck Polizei

59x30x44 4,8 kg 1x

60x40x30 5,6 kg 0,072 m³



4 006485 171101

2 17 119 4 Ferbedo Truck Racing

59x30x44 4,8 kg 1x

60x40x30 5,6 kg 0,072 m³



4 006485 171194

3 17 123 1 Ferbedo Truck Service

59x30x44 4,8 kg 1x

60x40x30 5,6 kg 0,072 m³



4 006485 171231



Ferbedo Truck

Länderversionen Einsatzfahrzeuge
Country-specific emergency vehicles
Versions nationales des véhicules d'intervention
Versioni nazionali veicoli d'intervento

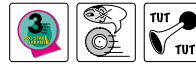

4



4 17 112 5 Ferbedo Truck Fire

59x30x44 4,8 kg 1x

60x40x30 5,6 kg 0,072 m³



4 006485 171125

I'm green

1

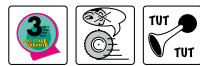

2



tüüüt tüüüt



3

tüüüt tüüüt



4





5



1 17 201 6 Ferbedo Truck BIO

59x30x44 4,8 kg 1x

60x40x30 5,6 kg 0,072 m³



4 006485 172016

2 17 200 9 Ferbedo Truck BIO

59x30x44 4,8 kg 1x

60x40x30 5,6 kg 0,072 m³



4 006485 172009

3 40 100 0 Ferbedo Mini Flash, blau

8x

4 006485 401000

4 40 101 7 Ferbedo Mini Flash, orange

8x

4 006485 401017

5 15 000 7 Ferbedo Tigerente

53x30x36 3,7 kg 1x

52,5x35x24 4,3 kg 0,044 m³



4 006485 150007



1



1 11 201 2 Ferbedo Gokart AR8R

111x72x66 14 kg 1x

115x71x28 15 kg 0,228 m³



2 11 200 5 Ferbedo Gokart AR8G

111x72x66 14 kg 1x

115x71x28 15 kg 0,228 m³



3 10 501 4 Ferbedo Gokart AirRunner

102x60x64 13,5 kg 1x

103x60x29 14,5 kg 0,167 m³



4 10 500 7 Ferbedo Gokart AT X-Racer

102x60x64 13,5 kg 1x

103x60x29 14,5 kg 0,167 m³



5 10 400 0 Ferbedo Gokart X-Racer

102x60x64 13,5 kg 1x

103x60x29 14,5 kg 0,167 m³



2



Ferbedo Gokarts

3



4



5





Franz Schneider GmbH & Co. KG

■ made
■ in
■ Germany